



ADDIS ABABA UNIVERSITY
INSTITUTE OF TECHNOLOGY
SCHOOL OF ELECTRICAL AND COMPUTER ENGINEERING

Comparison of Different Smart Antenna Beamforming Algorithms in Interference Suppression

By

Alemayehu Tamene

Advisor

Dr. Murad Ridwan

A Thesis Submitted to Addis Ababa University, School of Graduate Studies,
Institute of Technology, in Partial Fulfillment of the Requirements for the Degree
of Masters of Science in Electrical Engineering

July, 2016

Addis Ababa, Ethiopia

**ADDIS ABABA UNIVERSITY
INSTITUTE OF TECHNOLOGY
SCHOOL OF ELECTRICAL AND COMPUTER ENGINEERING**

**Comparison of Different Smart Antenna
Beamforming Algorithms in Interference Suppression**

By

Alemayehu Tamene

Approval by Board of Examiners

**Chairman, Dept. Graduate
Committee**

Signature

Dr. Murad Ridwan

Advisor

Signature

Internal Examiner

Signature

External Examiner

Signature

Declaration

I, the undersigned, declare that this thesis is my original work, has not been presented for a degree in this or any other university, and all sources of materials used for the thesis have been fully acknowledged.

Alemayehu Tamene

Name

Signature

Place: Addis Ababa

Date of Submission: _____

This thesis has been submitted for examination with my approval as a university advisor.

Dr. Murad Ridwan

Advisor's Name

signature

Acknowledgment

First and foremost, I would like to express my sincere gratitude to my respected advisor Dr. Murad Ridwan for his invaluable advice, incessant guidance and continuous encouragement throughout the course of my study and research. Without his guidance and encouragement several breakthroughs in this thesis would be impossible to be achieved.

I would also like to take this opportunity to acknowledge my friends and families for their support and love. Their encouragement during both bad times and good times always kept my spirits high.

Last but not least, I would like to give thanks to God since He has given me wisdom, health and all the necessities that I need for all these years

Abstract

Nowadays demand for using wireless technologies is increasing tremendously all over the world. This growth will necessitate demand for high capacity of network, frequency spectrum reuse and minimum channel interference. Smart antennas are one of the most promising technologies that will enable a higher capacity in wireless networks by effectively reducing multipath and co-channel interference. This is achieved by focusing the radiation only in the desired direction and adjusting itself to changing traffic conditions or signal environments. Thus, smart antennas are an effective counter measure to achieve these requirements because they offer less interference, flexibility, less weight, high speed, phase control independent of frequency and low propagation loss. Smart antennas combine the antenna array with signal processing to optimize automatically the beam pattern in response to the received signal. Basic concept in smart antenna technology is beamforming, its mainly used to create the radiation pattern of the antenna arrays by adding constructively the phase of the signals in the direction of desired targets and nulling the pattern of undesired targets.

The main aim of this thesis is to study systematic comparison of the performances such as side lobe level, null and mean square error of different adaptive algorithms for beamforming for smart antenna system. The strategy used to achieve the major aim is an in-depth investigation of three adaptive algorithms, the Least Mean Square (LMS), Recursive Least Squares (RLS) and the Sample Matrix Inversion (SMI). The Simulation results provided showed that the beam steering ability and nullifying capability was satisfactory for those algorithms but this performances degrades with increase in number of users. LMS algorithm had slow convergence rate beside simplicity. SMI and LMS algorithm have better performance in placing deep null towards the interferer position than RLS algorithms when separation between each users is less than half the first null beam width. The effect of antenna array number, antenna element spacing as well as increasing number of interferers on nulling the undesired user and sidelobes level has also been studied.

Key words: Beamforming, Sidelobes, Smart Antennas, LMS, SMI, RLS

Contents

Acknowledgment	i
Abstract	ii
Contents	iii
List of Figures	vi
List of Tables	viii
List of Acronyms	ix
1 Introduction	1
1.1 Background	1
1.2 Co-channel Interference	4
1.3 Statement of the Problem	5
1.4 Objectives	6
1.4.1 General Objective	6
1.4.2 Specific Objectives	6
1.5 Methodology	6
1.6 Literature Review	7
1.7 Contribution of the thesis	9
2 Antenna and Antenna Arrays	10
2.1 Basics of Antenna	10
2.2 Basic Antenna Parameter	10
2.2.1 Radiation Pattern	10
2.2.2 Beam Width	11
2.2.3 Sidelobes and Nulls	13
2.2.4 Bore sight	13
2.2.5 Directivity and Gain	13
2.2.6 Polarization	14
2.3 Antenna Arrays	14
2.4 Basic Parameters of Antenna Array	15
2.4.1 Array Factor (AF)	15

2.4.2	Beam Steering.....	15
2.4.3	Array Geometry and Element Spacing.....	16
2.5	Optimal Antenna.....	16
2.6	Adaptive Antenna.....	17
2.7	Smart Antenna.....	17
3	Smart Antenna Systems.....	19
3.1	Definition.....	19
3.2	Classification of Smart Antenna System.....	20
3.2.1	Switched-Beam Systems.....	20
3.2.2	Adaptive Array Systems.....	21
3.3	Benefits and Drawbacks of Smart Antenna.....	22
3.3.1	Benefits of Smart Antenna.....	22
3.3.2	Drawbacks of Smart Antennas.....	23
3.4	Beamforming.....	24
3.4.1	Classification of Beamforming.....	26
3.4.2	Types of Beamforming.....	26
3.4.3	Criteria for Optimal Beamforming.....	27
4	Adaptive Beamforming Algorithm.....	31
4.1	Adaptive Beamforming.....	31
4.2	Adaptive Beamforming Algorithm.....	33
4.2.1	LMS Algorithm.....	34
4.2.2	SMI (Sample Matrix Inversion) Algorithm.....	40
4.2.3	RLS algorithm.....	43
5	Simulation Results and Discussions.....	46
5.1	Simulation Result for Single Interferer.....	47
5.2	Simulation Result for Different Antenna Spacing.....	51
5.2.1	Effect of antenna array spacing using LMS algorithm.....	51
5.2.2	Effect of antenna array spacing using RLS algorithm.....	55
5.3	Simulation result for different number of antenna array.....	57
5.3.1	Effect of changing antenna array number using LMS algorithm.....	57
5.3.2	Effect of changing antenna array number using SMI algorithm.....	59

5.3.3	Effect of changing antenna array number using RLS algorithm	60
5.4	Simulation results for case of more than one interferer	61
5.5	Effect of arrival angle of separation between users	64
6	Conclusions and Recommendations for Future Work.....	66
6.1	Conclusion.....	66
6.2	Recommendation.....	67
References	67

List of Figures

Figure 1.1 Conventional and smart antennas	3
Figure 2.1 Radiation pattern and linear plot of radiation pattern and its associated lobes and beamwidth.....	12
Figure 3.1 Switched beam system	20
Figure 3.2 Switched scheme and adaptive scheme.....	21
Figure 3.3 Relative coverage area for low and high interference environment.....	22
Figure 3.4 Advantage of smart antenna over Omni-direction or traditional antenna.....	23
Figure 3.5 Adaptive beamforming algorithms.....	25
Figure 3.6 Beamforming algorithms.....	27
Figure 4.1 Block diagram of adaptive antenna system.....	32
Figure 4.2 LMS algorithm	35
Figure 4.4.3 Rectangular and polar plot when desired users is at 30 degree and interfere is at -50 degree.....	38
Figure 4.4 Array output and desired signal.....	38
Figure 4.5 Mean square error vs iteration number.....	39
Figure 4.6 Polar and normalized array factor plot for N=20	40
Figure 4.7 Mean square error vs iteration number and array output	40
Figure 4.8 Polar plot and normalized array factor representation for SMI algorithm N=20	42
Figure 5.1 Simulation results of radiation pattern, MSE and array output, using LMS ($d=0.5\lambda$, $N=8$ and arrival angle of 0° for user and 45° for interferer).	48
Figure 5.2 Simulation results of radiation pattern, using SMI ($d=0.5\lambda$, $N=8$ and arrival angle of 0° for user and 45° for interferer)	49
Figure 5.3 Simulation results of radiation pattern, using RLS ($d=0.5\lambda$, $N=8$ and arrival angle of 0° for user and 45° for interferer)	50
Figure 5.4 Simulation results of radiation pattern, using LMS, SMI and RLS ($d=0.5\lambda$, $N=8$ and arrival angle of 0° for user and 45° for interferer)	51
Figure 5.5 Simulation results using LMS for different antenna spacing ($d=0.3\lambda$, 0.4λ , 0.5λ , 0.6λ , 0.7λ , 0.8λ , 0.9λ , 1λ and 1.1λ)	53
Figure 5.6 Simulation results using SMI for different antenna spacing ($d=0.3\lambda$, 0.4λ , 0.5λ , 0.6λ , 0.7λ , 0.8λ , 0.9λ , 1λ and 1.1λ)	54
Figure 5.7 Simulation results using RLS for different antenna spacing ($d=0.3\lambda$, 0.4λ , 0.5λ , 0.6λ , 0.7λ , 0.8λ , 0.9λ , 1λ and 1.1λ)	56
Figure 5.8 Comparison of null depth for different antenna array spacing ($d=0.3\lambda$, 0.4λ , 0.5λ , 0.6λ , 0.7λ , 0.8λ , 0.9λ , 1λ and 1.1λ)	56
Figure 5.9 Simulation results using LMS for different antenna array numbers ($d=0.6\lambda$).....	59
Figure 5.10 Simulation results using SMI for different antenna array numbers ($d=0.6\lambda$).....	60
Figure 5.11 Simulation results using RLS for different antenna array numbers ($d=0.6\lambda$).....	61
Figure 5.12 Array output Vs desired signal ($d=0.6\lambda$, $\theta_s = 20^\circ$, $\theta_i = -30^\circ, -60^\circ, 50^\circ$ and 70°)	62

Figure 5.13 Mean square error ($d=0.6\lambda$, $\theta_s = 0^\circ$, $\theta_i = -30^\circ, -60^\circ, 30^\circ$ and 60°).....	62
Figure 5.14 Simulation results for comparing SLL and null ($d=0.6\lambda$, $N=8$, $\theta_s = 0^\circ$, $\theta_i = -30^\circ, -60^\circ, 30^\circ$ and 60°) for LMS, SMI and RLS algorithms.....	63
Figure 5.15 Simulation results for comparing sidelobes and null ($d=0.6\lambda$, $N=8$, $\theta_s = 0^\circ$, $\theta_i = -33^\circ, -22^\circ, -11^\circ, 11^\circ, 22^\circ$ and 33°) for LMS, SMI and RLS algorithms in cases of six interferer where arrival angle of separation 11°	65

List of Tables

Table 4.1 Summary of LMS equations	36
Table 4.2 Optimum weight vector	39
Table 4.3 Optimum weight vector for SMI	42
Table 5.1 Simulation parameters and assumptions.....	46
Table 5.2 Comparison of value of null in undesired direction, side lobe level and first null	50
Table 5.3 Comparison of value of null in undesired direction, side lobe level and first null ($d=0.6\lambda$, $N=8$, $\theta_s=0^\circ$, $\theta_i=-30^\circ, -60^\circ, 30^\circ$ and 60°) for LMS, SMI and RLS algorithms.....	63
Table 5.4 Comparison of value of null in undesired direction, side lobe level and first null ($d=0.6\lambda$, $N=8$, $\theta_s = 0^\circ$, $\theta_i = -33^\circ, -22^\circ, -11^\circ, 11^\circ, 22^\circ$ and 33°) for LMS, SMI and RLS algorithms in cases of six interferer where arrival angle of separation 11°	64

List of Acronyms

Abbreviation	Description
ADC	Analog to Digital converter
AF	Array Factor
AWGN	Additive White Gaussian Noise
BER	Bit Error Rate
CG	Conjugate Gradient
CMA	Constant Module Algorithm
DOA	Direction of arrival
FNBW	First Null Beamwidth
HPBW	Half Power Beamwidth
LMS	Least Mean Square
LS-CMA	Least Square constant module algorithm
MI-NLMS	Matrix Inversion Normalized Least Mean Square
ML	Maximum Likelihood
MMSE	Minimum Mean Squared Error
MSR	Mean Square Error
NLMS	Normalized Least Mean Square
RLS	Recursive Least square
SDMA	Space Division Multiple Access
SINR	Signal-to-Interference-plus-Noise ratio
SIR	Signal-to-Interference Ratio
SMI	Sample Matrix Inversion
SNOI	Signal Not of Interest
SNR	Signal-to-Noise Ratio
SOI	Signal of Interest
ULA	Uniform Linear Array

Chapter 1

1 Introduction

1.1 Background

As the number of users and demand for wireless services are increasing at an exponential rate, the need for wider coverage area, improved capacity and higher transmission quality rises. Thus a more effective use of the radio spectrum is required. A smart antenna system are capable of efficiently utilizing the radio spectrum and is a promise for an effective solution to the present wireless systems problems while achieving reliable and robust high speed high data rate transmission [1]. The technologies (Third Generation-3G and Fourth Generation-4G) are adopting the Space Division Multiple Access (SDMA) technique with Smart Antenna System. With this antenna architecture, the weights of the antennas are adapted to point the main beam in the desired direction and place nulls in the interference directions.

The term “smart antenna” generally refers to any antenna array, terminated in a sophisticated signal processor, which can adjust or adapt its own beam pattern in order to emphasize signals of interest and to minimize interfering signals [2]. Functionality of smart antenna system is properly understood when it is related to our human body system. The brain is working as human signal processor, computes the direction of the speaker from time delays of the voice which is received by the two ears. The brain adds the signal strength from each ear and focus on the sound of the particular direction. If additional speaker is participate in the conversation. The brain can tuned out unwanted interference and concentrate on one conversation at a time. And the listeners can response back to the same direction of the desired speaker by orienting the transmitter (mouth) toward the speaker [3].

Electrically smart antenna systems work the same way using two antennas instead of ears. And instead of brain digital signal processor is used. By using smart antenna architecture the weights of the antennas are adapted to point the main lobe in the particular direction and nulls are placed in the interference directions. Different algorithms are used for weight updating that is updating phase and amplitude [3].

Smart antennas generally encompass both switched beam and beam forming adaptive systems. Switched beam systems have several available fixed beam patterns. A decision is made as to which beam to access, at any given point in time, based upon the requirements of the system. Beam formed adaptive systems allow the antenna to steer the beam to any direction of interest while simultaneously nulling interfering signals. The smart antenna concept is opposed to the fixed beam “dumb antenna,” which does not attempt to adapt its radiation pattern to an ever-changing electromagnetic environment [2].

In the past, smart antennas have alternatively been labeled adaptive arrays or digital beam forming arrays. This new terminology reflects our penchant for “smart” technologies and more accurately identifies an adaptive array that is controlled by sophisticated signal processing [2]. Smart antenna is one of the most promising technologies that will enable a higher capacity in wireless networks by effectively reducing multipath and co-channel interference. This can be achieved by focusing the radiation only in the desired direction and adjusting itself to changing traffic conditions or signal environments. Smart antennas are also known as adaptive array antennas [1].

Figure below contrasts two antenna arrays. The first is a traditional, fixed beam array where the main lobe can be steered, by defining the fixed array weights w . However, this configuration is neither smart nor adaptive. The second array in the figure is a smart antenna designed to adapt to a changing signal environment in order to optimize a given algorithm. An optimizing criterion, or cost function, is normally defined based upon the requirements at hand. In this example, the cost function is defined as the magnitude of the error squared, $|\varepsilon|^2$, between the desired signal d and the array output y . The array weights are adjusted until the output matches the desired signal and the cost function is minimized. This results in an optimum radiation pattern [2].

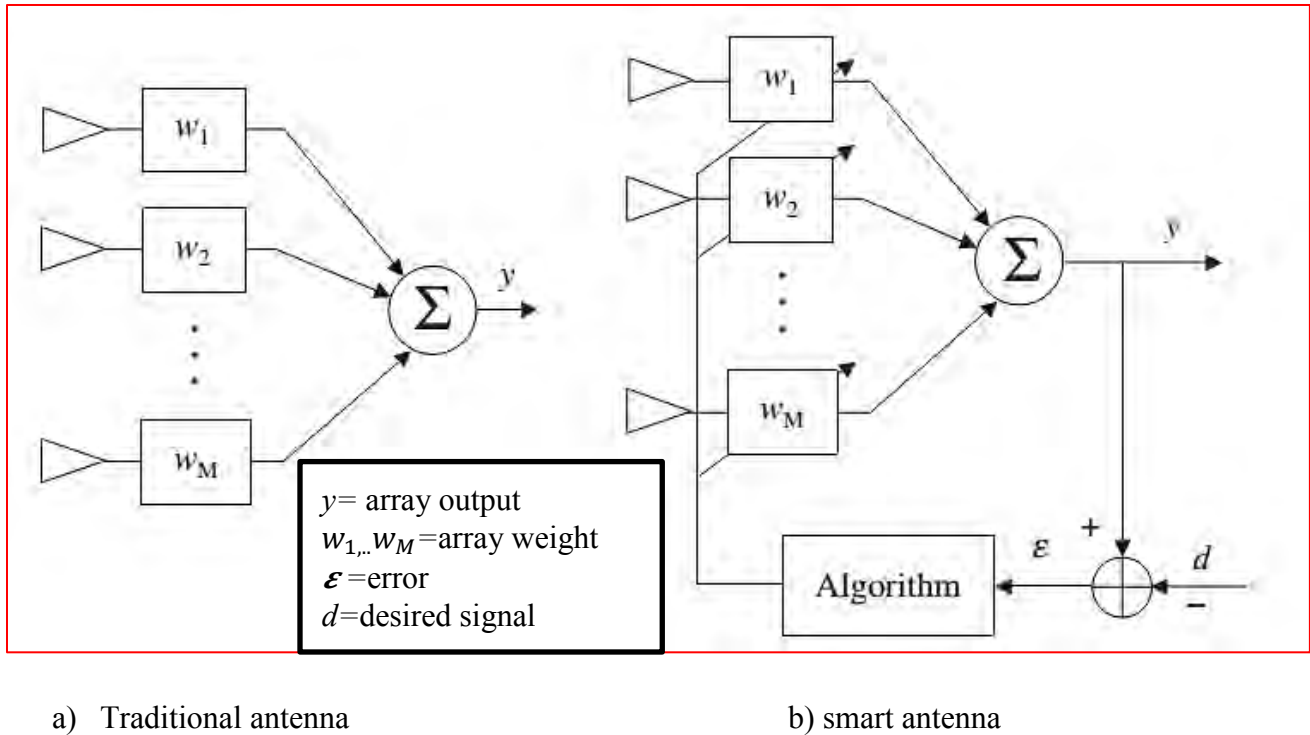

Figure 1.1 Conventional and smart antennas [2]

Smart antennas or adaptive arrays are dynamically able to adapt to the changing traffic requirements. As long as the users are well separated spatially same frequency can be reused, even if the users are in the same cell. The process of combining the signals and then focusing the radiation in a particular direction is often referred to as digital beam forming. It is mainly used to calculate beamforming vectors and to track & locate the antenna beam on the mobile target device.

Smart antenna increase network capacity by precise control of signal nulls quality and mitigation of interference combine to frequency reuse. It increases revenues of network operators and gives customers less probability of blocked or dropped calls. Adaptive beamforming is a technique in which an array of antennas is exploited to achieve maximum reception in a specified direction by estimating the signal arrival from a desired direction (in the presence of noise) while signals of the same frequency from other directions are rejected.

1.2 Co-channel Interference

Imagine stone dropped into perfectly still pool of water. Consequently waves will radiate outward from that point. These waves are uniform and will diminish in strength evenly, equivalent to one caller's signal originating at the terminal and going uplink. In same way consider a base station at some distance from the wave origin and assume that the pattern is not disturbed by the wave created, thus base station can easily interpret the waves. But signal strength will diminish if signal's waves bounce off the edges of the pool and come back to intersect with the original wave pattern. These are multipath interference problems [4].

One of the primary forms of man-made signal degradation associated with digital radio, co-channel interference occurs when the same carrier frequency reaches the same receiver from two separate transmitters. Since both broadcast antennas as well as more focused antenna systems scatter signals across relatively wide areas. The signals that miss an intended user can become interference for users on the same frequency in the same or adjoining cells [4].

Thus co-channel interference problem comes in the case where a few more stones being dropped in different areas of the pool, equivalent to other calls starting. Thus its challenge for base station at any particular point in the pool to know which stone's signals was being picked up and from which direction [4].

Minimizing co-channel interference is the number-one limiting factor in maximizing the capacity of a wireless system. In order to minimize the effects of co-channel interference, smart antenna systems not only focus directionally on intended users, but in many cases direct nulls towards undesired users [4].

1.3 Statement of the Problem

In future, wireless mobile communication systems will be more sophisticated and wider spread. This growth has triggered an enormous demand not only for capacity but also better coverage and higher quality of service. Smart antenna is one of the most promising technologies that will enable a higher capacity in wireless networks by effectively reducing multipath and co-channel interference [2]. This can be achieved by focusing the radiation only in the desired direction and adjusting itself to changing traffic conditions or signal environments, by using digital beamforming. Adaptive beamforming is a technique in which an array of antennas is exploited to achieve maximum reception in a specified direction by estimating the signal arrival from a desired direction (in the presence of noise) while signals of the same frequency from other directions are rejected. Thus, the purpose of almost all beamforming algorithms is to form multiple beams towards desired users while nulling to the interferers at the same time, through the adjustment of the beam former's weight vectors.

Although smart antenna system has numerous advantageous compared to traditional beamforming arrays, it has limitations on the performance characteristics like computational complexity, speed of convergence, beam steering ability, nullifying capability and side lobe level. However does the adaptive algorithms perform well and functioning properly in steering the main beam toward the desired users and tracking them, also rejecting the interferers at the same time and do the spatial filtering? And how that could improve the capacity and performance of the whole system? After that kind of investigation the outcomes of deploying and utilizing smart antenna systems and their adaptive algorithms in the area of mobile communications will be clearly stated.

Thus, the ultimate solution is based on investigating and intensively studying Adaptive beamforming algorithms such as: Least Mean Square (LMS), Recursive Least Square (RLS) and Sample Matrix Inversion (SMI), through extensive analysis, and simulation, to provide substantial performance improvements. Speed of convergence, beam steering ability, nullifying capability and other performance measurements criterion must be analyzed and

compared for those algorithms and suggestions are made that which one is the best according to an application.

1.4 Objectives

1.4.1 General Objective

The general objective of the thesis is to have a thorough understanding of a fully adaptive beamforming approach based on smart antennas. The focus and main objective of this thesis is investigation and comparison different smart antenna beamforming for interference reduction.

1.4.2 Specific Objectives

The specific objectives are:

- To study and assess different adaptive beamforming algorithms.
- To investigate effects of separation angle between user on null and side lobe level.
- To investigate effects of changing antenna array number and antenna spacing.
- To study performances of adaptive beamforming algorithm for different cases by changing number of interferer to the source.
- Recommend algorithm with best antenna spacing for low side lobe level and nulling the interference sources.

1.5 Methodology

The methods to be employed to achieve the objectives of the project are:

Literature Review

Includes reading books, articles, simulation tools and other resources related to the topic, to helping me understand the nature of the problem that need to be solved and its importance, also reviewing the important aspects related to the topic.

System Modeling

Involves Matlab simulation along with the mathematical formulation of adaptive beamforming algorithm that is used in this thesis.

Simulation and Analysis of the Results

Matlab programming is used for simulating the modeled communication system using the adaptive beamforming algorithm. The results obtained from the simulation will be analyzed and compared based on performance analysis criteria's. Therefore the research finding can be clearly stated, thus based on it the conclusion is derived.

1.6 Literature Review

So far many researches have been conducted on smart antenna system and its adaptive beamforming algorithms. Short literature surveys of some selected papers are reviewed here.

Most of the works mainly focus on either comparing the available algorithm based on different performance criterion [7] and [9] or developing the new one or modifying the available algorithm to make it robust against any steering and signal vector error and to enhance the performance of the system[6], [8], and [14]. And mostly an algorithm with less complexity, low computational cost, good convergence rate, robust to signal and steering vector error, steer the main lobe towards the signal of interest is usually preferred.

In [6] and [8] the performance of adaptive beamforming algorithm such as: least mean square, sample matrix inversion, Normalized Least Mean Square (NLMS), recursive least square, Constant module algorithm (CMA), Least Square Constant Module (LS-CMA), are studied. These adaptive algorithms are analyzed based on computational complexity, cost of implementation, beam steering ability, nullifying capability, side lobe level, beam pattern and amplitudes for different channel types. Simulation results show that LMS has low speed of convergence, successfully steer the main lobe of antenna array towards the desired signal but unsatisfactory to nullify the interference compared to the other. The other adaptive algorithms have fast speed of convergence and forming deep nulls but high computational cost.

In [8], [10] training sequence algorithms RLS, LMS, and CMA are analyzed. In addition to criterion above error plot, BER and the effect of changing step size are also considered. Simulation results show that besides the computational complexity RLS has the best performance under the above performance criterions.

LMS and NLMS are studied in [10] and [16] based on computational complexity, stability under variation of weight, interference rejection, beam steering ability and speed of convergence as a criteria. Simulation results show that LMS has less speed of convergence, less computational cost, good response towards the desired direction and better capability to place null towards the interferer compared to NLMS. Thus LMS is preferred for such types of condition. NLMS has high computational cost however it has high stability as a variation of weights and high speed of convergence. Hence here NLMS is preferred.

Reference [11] and [14] present a novel adaptive beamforming algorithm the MI-NLMS for smart antenna system which combines the NLMS and sample matrix inversion algorithm to improve the convergence speed with small Bit Error Rate (BER). Simulation result showed that the MI-NLMS algorithm provides remarkable improvements in terms of interference rejection, convergence rate and BER over those of LMS and NLMS algorithms.

References [10], [12] and [15] compare the performance of LMS adaptive beamforming algorithm with respect to antenna array size, elements forming this array, physical spacing and the signal environment parameters are analyzed in terms of the number of signals incident on the antenna array and their angular separation. Simulation results showed that the performance LMS adaptive beamforming improves as more are used in the antenna array. The improvement is seen in the form of sharper beams directed towards the desire users. Regarding the spacing between the antenna elements, it was reported that using small or large spacing values could degrade the performance, an element spacing values of 0.5λ was found to be a good values to ensure successful performance of the LMS beam former. The effect of incident signals on the antenna array has been studied too and it was concluded that the performance of the beam former degrades as more signals are incident on the linear array. How antenna array used in communication system and suggest ways of improving system performance is also studied.

This thesis mainly focuses on studying the effect of antenna array number, spacing as well as effect of changing number of user and arrival angle of separation between user on the performance criterions (side lobe level and Nulling) which are not analyzed in detail based on varying the array parameters for smart antenna system. Such types of issues need to be analyzed more to recommend an algorithm and array parameters which is best, under a given performance criterion.

1.7 Contribution of the thesis

In all the literatures seen so far in Section 1.6, smart antenna beamforming has been investigated at various levels. However, some of the major contributions of the thesis are underlined in the following points

- The performances (nulling and side lobe level) of adaptive beamforming algorithm such as: RLS, SMI and LMS is studied in detail.
- The effect of array element spacing, number of antenna array and increasing number of users on the performance of smart antenna system is investigated.
- The effect of arrival angle of separation between each user is studied for various angle of separation. In the simulation, separation of less than 15° (which less than half the first null beam width) is considered for detail comparison for each algorithm and compared with the previous result where separation of more than 20° is used.

Chapter 2

2 Antenna and Antenna Arrays

In this Chapter, brief discussion of basics of antenna and antenna arrays and parameters are provided.

2.1 Basics of Antenna

As stated by Kraus [5], antenna may be defined as the structure associated with the region of transition between a guided wave and free space wave, or vice versa. An antenna is a transducer that converts guided electromagnetic waves from transmission lines to a free space unbounded wave in its transmission mode and converts free space waves to guided waves in its reception mode. It demonstrates a property known as reciprocity, which means that an antenna will maintain the same characteristics regardless if it is transmitting or receiving.

In addition to receiving or transmitting energy, an antenna in an advanced wireless system is usually required to optimize or accentuate the radiation energy in some directions and suppress it in others. Thus the antenna must also serve as a directional device in addition to a probing device. There are different types of antenna. The isotropic point source radiator, one of the basic theoretical radiators, is useful because it can be considered a reference to other antennas. The isotropic point source radiates equally in all direction in free space [5]. Here some important parameters are defined that are basic and related to every type of antenna

2.2 Basic Antenna Parameter

2.2.1 Radiation Pattern

An antenna radiation pattern or antenna pattern is defined as “a mathematical function or a graphical representation of the radiation properties of the antenna as a function of space

coordinates. The radiation or antenna pattern describes the relative strength of the radiated field in various directions from the antenna, at a constant distance. The radiation pattern is a reception pattern as well, since it also describes the receiving properties of the antenna. The radiation pattern is three-dimensional, but usually the measured radiation patterns are a two dimensional slice of the three-dimensional pattern, in the horizontal or vertical planes. These pattern measurements are presented in either a rectangular or a polar format. The radiation pattern consists of a main lobe where the intensity is maximum and some side lobes that are pointed at different directions and don't contribute to the antenna performance [6].

The radiation pattern in the region close to the antenna is not the same as the pattern at large distances. The term near-field refers to the field pattern that exists close to the antenna, while the term far field refers to the field pattern at large distances. The far field is also called the radiation field, and is what is most commonly of interest. Ordinarily, it is the radiated power that is of interest, and so antenna patterns are usually measured in the far-field region [6].

2.2.2 Beam Width

Associated with the pattern of an antenna is a parameter designated as beamwidth. The beam width of a pattern is defined as the angular separation between two identical points on opposite side of the pattern maximum. In an antenna pattern, there are a number of beam widths. One of the most widely used beam widths is the Half-Power Beamwidth (HPBW), which is defined by IEEE as: "In a plane containing the direction of the maximum of a beam, the angle between the two directions in which the radiation intensity is one-half value of the beam." Another important beamwidth is the angular separation between the first nulls of the pattern, and it is referred to as the First-Null Beamwidth (FNBW) [6].

The beamwidth of an antenna is a very important figure of merit and often is used as a trade-off between it and the side lobe level; that is, as the beamwidth decreases, the side lobe increases and vice versa [6]. In addition, the beamwidth of the antenna is also used to describe the resolution capabilities of the antenna to distinguish between two adjacent radiating sources or radar targets. The most common resolution criterion states that the resolution capability of an antenna to distinguish between two sources is equal to half the first-null beamwidth (FNBW/2),

which is usually used to approximate the half power beamwidth (HPBW). That is, two sources separated by angular distances equal or greater than $FNBW/2 \approx HPBW$ of an antenna with a uniform distribution can be resolved. If the separation is smaller, then the antenna will tend to smooth the angular separation distance.

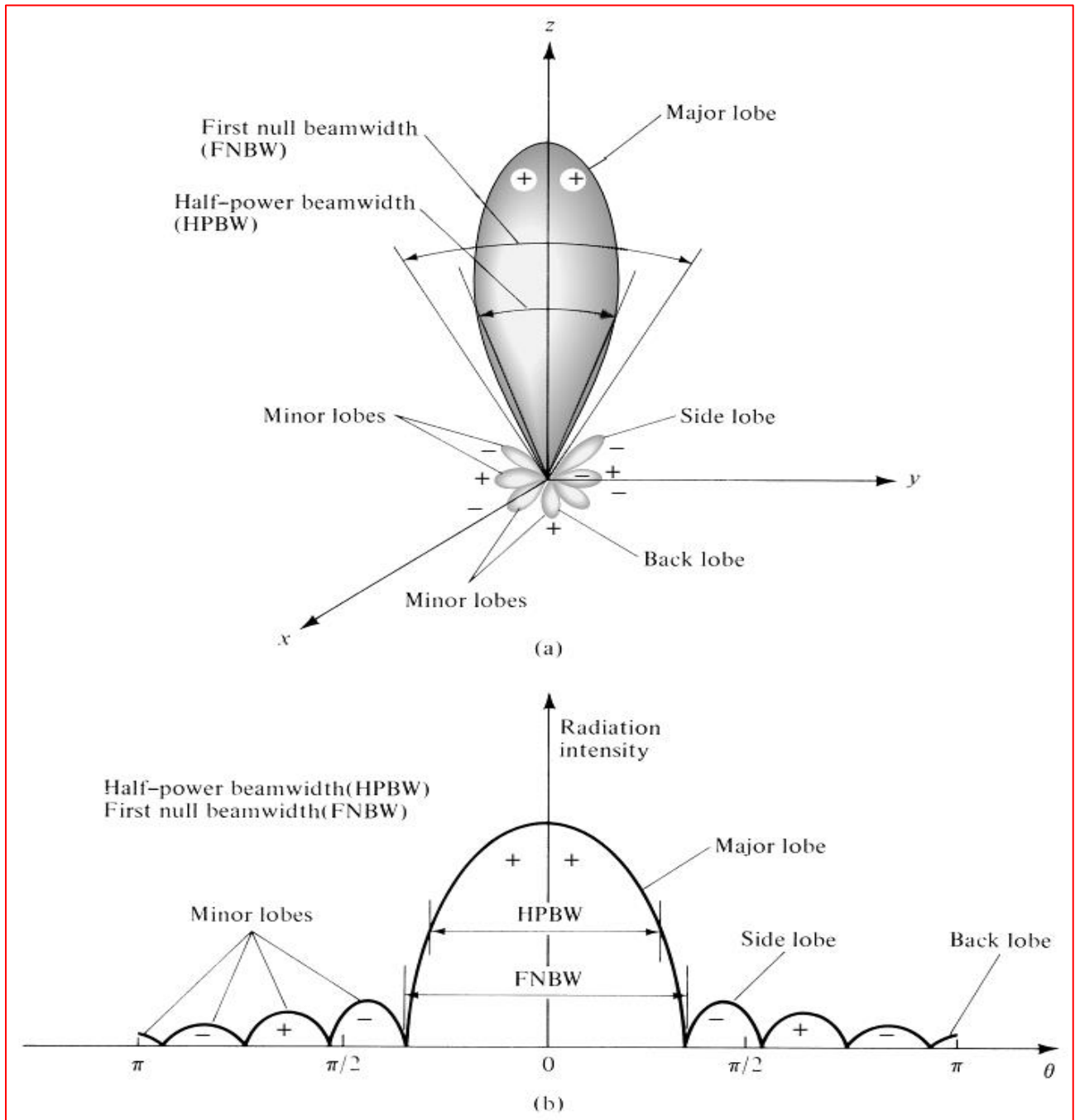

Figure 2.1 Radiation pattern and linear plot of radiation pattern and its associated lobes and beamwidth [3]

2.2.3 Sidelobes and Nulls

No antenna is able to radiate all the energy in one preferred direction [1]. Some energy is inevitably in other direction with lower levels than the main lobe. The smaller peaks are referred to as sidelobes, commonly specified in dB down from the main lobe. In an antenna radiation pattern, a null is a zone in which the effective radiated power is at a minimum. A null often has a narrow directivity angle compared to that of the main beam. Thus, the null is useful for several purposes, such as suppression of interfering signals in a given direction [6].

2.2.4 Bore sight

The antenna bore sight is the intended physical aiming direction or the location at where the radiation pattern needs to be maximized. In other words, it is the normally intended direction for maximum radiation [6].

2.2.5 Directivity and Gain

According to Balanis [3] directivity of an antenna defined as “the ratio of the radiation intensity in a given direction from the antenna to the radiation intensity averaged over all directions. The average radiation intensity is equal to the total power radiated by the antenna divided by 4π . If the direction is not specified, the direction of maximum radiation intensity is implied.” Thus Directivity is the ability of an antenna to focus energy in a particular direction when transmitting, or to receive energy better from a particular direction when receiving.

Omnidirectional antennas radiate equal amounts of power in all directions. Also known as isotropic antennas, they have equal gain in all directions. Directional antennas, on the other hand, have more gain in certain directions and less in others. The gain of directional antennas in the bore sight is more than that of omnidirectional antennas, and is measured with respect to the gain of omnidirectional antennas. An antenna may be used to transmit or receive. The gain of an antenna remains the same in both the cases. The gain of a receiving antenna indicates the amount of power it delivers to the receiver compared to an omnidirectional antenna [6].

The gain of an antenna in a given direction is the amount of energy radiated in that direction compared to the energy an isotropic antenna would radiate in the same direction when driven with the same input power. Usually we are only interested in the maximum gain, which is the gain in the direction in which the antenna is radiating most of the power. An antenna gain of 3 dB compared to an isotropic antenna would be written as 3 dBi. The resonant half-wave dipole can be a useful standard for comparing to other antennas at one frequency or over a very narrow band of frequencies[6].

2.2.6 Polarization

Polarization of an antenna in a given direction is defined as “the polarization of the wave transmitted (radiated) by the antenna. In practice, polarization of the radiated energy varies with the direction from the center of the antenna, so that different parts of the pattern may have different polarizations [6].

The polarization of a wave can be defined in terms of a wave radiated (transmitted) or received by an antenna in a given direction. The polarization of a wave radiated by an antenna in a specified direction at a point in the far field is defined as “the polarization of the (locally) plane wave which is used to represent the radiated wave at that point [3].

In general polarization may be classified as linear, circular, or elliptical. If the vector that describes the electric field at a point in space as a function of time is always directed along a line, the field is said to be linearly polarized.

2.3 Antenna Arrays

An antenna array is a set of antenna elements arranged in space whose outputs are combined to give an overall antenna pattern that can differ from the pattern of the individual elements. An array can achieve the same directional performance of a larger antenna by trading the electrical problems of combining several antenna outputs for the mechanical problems of supporting and turning a large antenna. By varying the phase and amplitude of the individual element outputs before combining, the overall array pattern can

be steered in the desired user's direction without physically moving any of the individual elements. The overall radiation pattern of an array is determined by the radiation pattern of the individual elements, their positions, orientations in space, and the relative phase and amplitudes of the feeding currents to the elements and amplitudes of the feeding currents to the elements [3].

By the principle of pattern multiplication, the overall radiation pattern form is found as the product of the individual element radiation patterns with the array factor. The array factor is in turn determined by the relative positions of the elements in space as well as the relative phase and amplitude levels of the feeding currents to the elements. An array of antenna performs better compared to the single antenna element. It can steer the beams and put nulls in the desire and interfere point accordingly the need of the user.

2.4 Basic Parameters of Antenna Array

2.4.1 Array Factor (AF)

The radiation pattern of antenna array is given by the product of array factor and element factor. If we assume all elements radiates in all direction equally, the radiation pattern is equal to the array factor.

2.4.2 Beam Steering

For a given array the beam may be pointed in different directions by mechanically moving the array. This is known as mechanical steering [6]. Beam steering can also be accomplished by appropriately delaying the signals before combining. The process is known as electronic steering, and no mechanical movement occurs. For narrowband signals, the phase shifters are used to change the phase of signals before combining.

The required delay may also be accomplished by inserting varying lengths of coaxial cables between the antenna elements and the combiner. Changing the combinations of various lengths of these cables leads to different pointing directions. Switching between different combinations of beam-steering networks to point beams in different directions is sometimes referred to as beam switching. When processing is carried out digitally, the signals from various elements can

be sampled, stored, and summed after appropriate delays to form beams. The required delay is provided by selecting samples from different elements such that the selected samples are taken at different times. Each sample is delayed by an integer multiple of the sampling interval; thus, a beam can only be pointed in selected directions when using this technique

2.4.3 Array Geometry and Element Spacing

Spacing between the antenna elements is an important factor in the design of an antenna array. Grating lobes appears in the antenna pattern if the elements are more than λ apart, where λ is the wavelength of the signal which is given by $3 \times 10^8 / fc$, fc is the carrier frequency. Mutual coupling is an effect that limits the inter-element spacing of an array. If the elements are spaced closely, the coupling effects will be larger and generally tends to decrease with increase in the spacing. The mutual coupling effect depends on the array geometry and the radiation pattern of element in the array.

2.5 Optimal Antenna

An antenna is optimal when the weight of each antenna element is adjusted to achieve optimal performance of an array system in some sense. For example, assume that a communication system is operating in the presence of unwanted interferences. Furthermore, the desired signal and interferences are operating at the same carrier frequency such that these interferences cannot be eliminated by filtering. The optimal performance for a communication system in such a situation may be to maximize the signal-to-noise ratio (SNR) at the output of the system without causing any signal distortion. This would require adjusting the antenna pattern to cancel these interferences with the main beam pointed in the signal direction. Thus, the communication system is said to be employing an optimal antenna when the gain and the phase of the signal induced on each element are adjusted to achieve the maximum output SNR (sometimes also referred to as signal to interference and noise ratio, SINR) [6].

2.6 Adaptive Antenna

The term adaptive antenna is used for a phased array when the weighting on each element is applied in a dynamic fashion. The amount of weighting on each channel is not fixed at the time of the array design, but rather decided by the system at the time of processing the signals to meet required objectives. In other words, the array pattern adapts to the situation and the adaptive process is under control of the system. For example, consider the situation of a communication system operating in the presence of a directional interference operating at the carrier frequency used by the desired signal, and the performance measure is to maximize the output SNR [6].

As discussed previously, the output SNR is maximized by canceling the directional interference using optimal antennas. The antenna pattern in this case has a main beam pointed in the desired signal direction, and has a null in the direction of the interference. Assume that the interference is not stationary but moving slowly. If optimal performance is to be maintained, the antenna pattern needs to adjust so that the null position remains in the moving interference direction. A system using adaptive antennas adjusts the weighting on each channel with an aim to achieve such a pattern. For adaptive antennas, the conventional antenna pattern concepts of beam width, side lobes, and main beams are not used, as the antenna weights are designed to achieve a set performance criterion such as maximization of the output SNR. On the other hand, in conventional phase-array design these characteristics are specified at the time of design [6].

2.7 Smart Antenna

The term smart antenna incorporates all situations in which a system is using an antenna array and the antenna pattern is dynamically adjusted by the system as required. Thus, a system employing smart antennas processes signals induced on a sensor array. Many refer to smart-antenna systems as smart antennas, but in reality antennas are not smart; it is the digital signal processing, along with the antennas, which makes the system smart. Although it might seem that a smart-antenna system is a new technology, the fundamental theory of smart (adaptive) antennas is not new [3].

Smart-antenna systems are basically an extension of cell sectoring in which the sector coverage is composed of multiple beams [3]. Because smart antennas can focus their radiation pattern toward the desired users while rejecting unwanted interferences, they can provide greater coverage area for each base station. Moreover, because smart antennas have a higher rejection interference, and therefore lower bit error rate (BER), they can provide a substantial capacity improvement.

Chapter 3

3 Smart Antenna Systems

3.1 Definition

A smart antenna system combines multiple antenna elements with a signal processing capability to optimize its radiation and/or reception pattern automatically in response to the signal environment. The concept of using multiple antennas and innovative signal processing to serve cells more intelligently has existed for many years. In fact, varying degrees of relatively costly smart antenna systems have already been applied in defense systems. Until recent years, cost barriers have prevented their use in commercial systems. The advent of powerful low-cost digital signal processors and general-purpose processors, as well as innovative software-based signal-processing techniques (algorithms) have made intelligent antennas practical for cellular communications systems [2].

Today, when spectrally efficient solutions are increasingly a business imperative, these systems are providing greater coverage area for each cell site, higher rejection of interference, and substantial capacity improvements.

In truth, antennas are not smart antenna systems are smart [3]. Generally co-located with a base station, a smart antenna system combines an antenna array with a digital signal-processing capability to transmit and receive in an adaptive, spatially sensitive manner. In other words, such a system can automatically change the directionality of its radiation patterns in response to its signal environment. This can dramatically increase the performance characteristics (such as capacity) of a wireless system [2].

Smart antenna systems are basically an extension of cell sectoring in which the sector coverage is composed of multiple beams. This is achieved by the use of antenna arrays, and the number of beams in the sector (e.g., 120°) is a function of the array geometry. Because smart antennas can focus their radiation pattern toward the desired users while rejecting unwanted interferences, they can provide greater coverage area for each base station. Moreover, because smart antennas

have a higher rejection interference, and therefore lower bit error rate, they can provide a substantial capacity improvement [3].

3.2 Classification of Smart Antenna System

3.2.1 Switched-Beam Systems

A switched-beam system is a system that can choose from one of many predefined patterns in order to enhance the received signal, and it is obviously an extension of cell sectoring as each sector is subdivided into smaller sectors. As the mobile unit moves throughout the cell, the switched-beam system detects the signal strength, chooses the appropriate predefined beam pattern, and continually switches the beams as necessary. The overall goal of the switched-beam system is to increase the gain according to the location of the user. However, since the beams are fixed, the intended user may not be in the center of any given main beam. If there is an interferer near the center of the active beam, it may be enhanced more than the desired user [3].

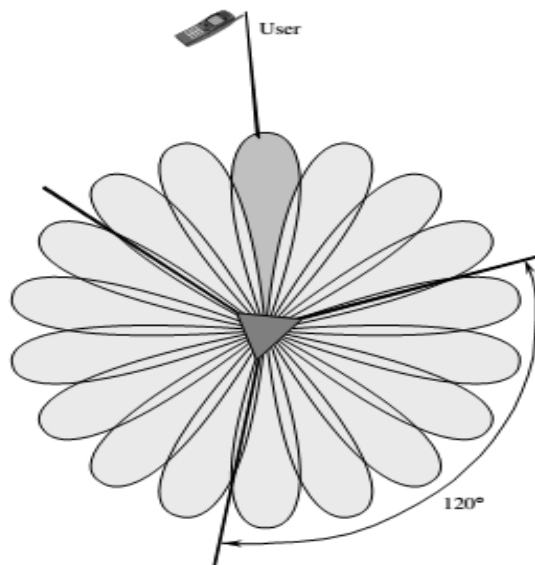

Figure 3.1 Switched beam system [3]

3.2.2 Adaptive Array Systems

Adaptive array systems provide more degrees of freedom since they have the ability to adapt in real time the radiation pattern to the RF signal environment. In the words, they can direct the main beam toward the pilot signal or SOI while suppressing the antenna pattern in the direction of the interferers or SNOIs. To put it simply, adaptive array systems can customize an appropriate radiation pattern for each individual user. The figure below shows that not only the switched-beam system may not able to place the desired signal at the maximum of the main lobe but also it exhibits the in ability to fully reject the interferers [3].

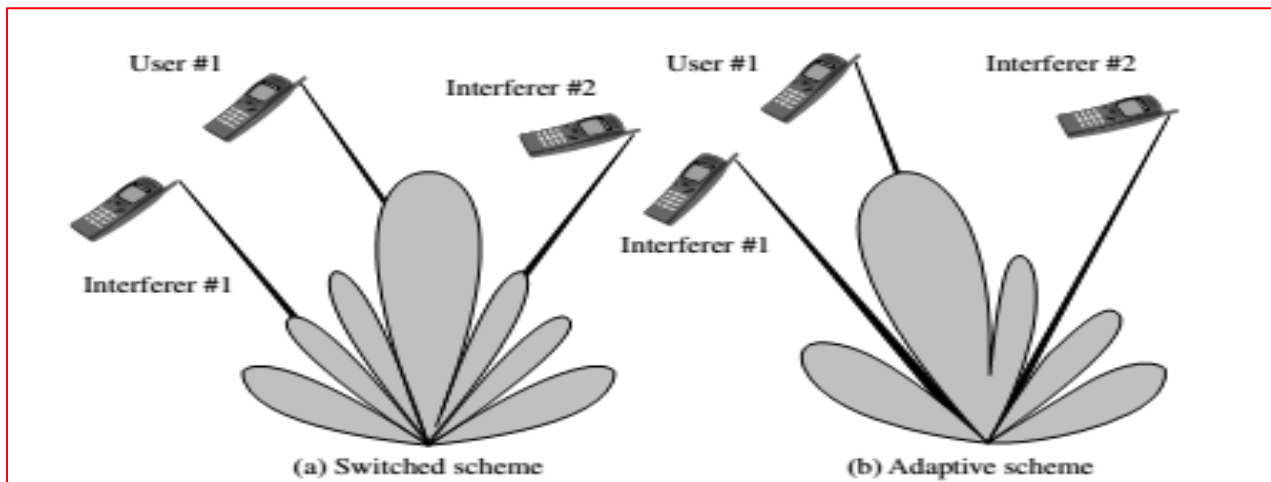
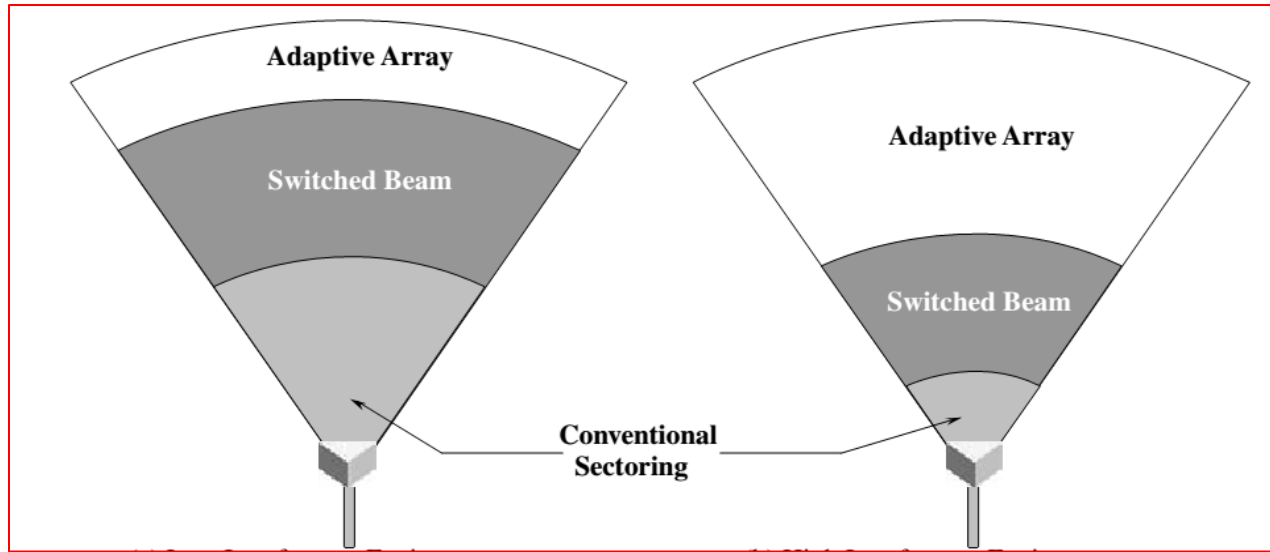

Figure 3.2 Switched scheme and adaptive scheme [3]

Figure below shows a comparison, in terms of relative coverage area, of conventional sectorized switched-beam and adaptive arrays. In the presence of a low-level interference, both types of smart antennas provide significant gains over the conventional sectorized systems. However, when a high-level interference is present, the interference rejection capability of the adaptive systems provides significantly more coverage than either the conventional or switched-beam system.

Adaptive array systems can locate and track signals (users and interferers) and dynamically adjust the antenna pattern to enhance reception while minimizing interference using signal processing algorithms.



a) Low interference environment

b) High interference environment

Figure 3.3 Relative coverage area for low and high interference environment [3]

3.3 Benefits and Drawbacks of Smart Antenna

3.3.1 Benefits of Smart Antenna

The primary reason for the growing interest in smart-antenna systems is the capacity increase. In densely populated areas, mobile systems are usually interference-limited, meaning that the interference from other users is the main source of noise in the system. This means that the signal-to-interference ratio (SIR) is much smaller than the signal-to-noise ratio (SNR). In general, smart antennas will, by simultaneously increasing the useful received signal level and lowering the interference level, increase the SIR [3].

Another benefit that smart-antenna systems provide is range increase. Because smart antennas are more directional than omnidirectional and sectorized antennas, a range increase potential is available. In other words, smart antennas are able to focus their energy toward the intended users, instead of directing it in other unnecessary directions (wasting) like omnidirectional antennas do. This means that base stations can be placed further apart, leading to a more cost-

efficient development. Therefore, in rural and sparsely populated areas, where radio coverage rather than capacity is more important, smart-antenna systems are also well suited [2].

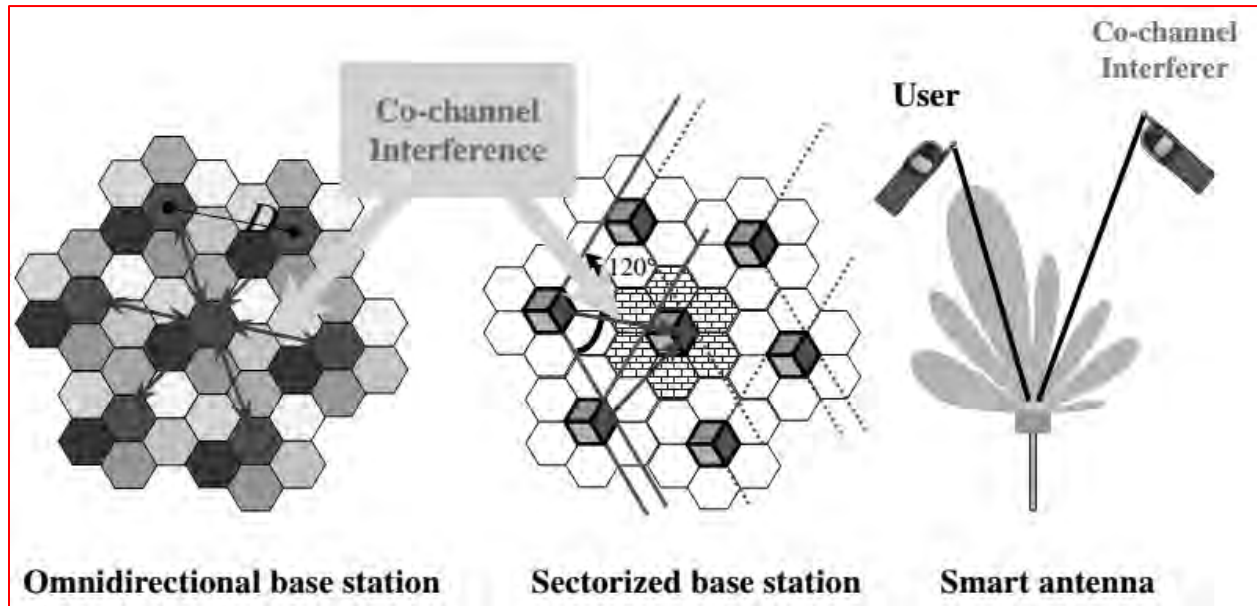

Figure 3.4 Advantage of smart antenna over Omni-direction or traditional antenna [3]

Another added advantage of smart-antenna systems is security. In a society that becomes more dependent on conducting business and transmitting personal information, security is an important issue. Smart antennas make it more difficult to tap a connection because the intruder must be positioned in the same direction as the user as seen from the base station to successfully tap a connection [3].

3.3.2 Drawbacks of Smart Antennas

Smart antenna transceivers are much more complex than traditional base station transceivers. The antenna needs separate transceiver chains for each array antenna element and accurate real-time calibration for each of them. Moreover, the antenna beamforming is computationally intensive, which means that smart antenna base stations must be equipped with very powerful digital signal processors. This tends to increase the system costs in the short term, but since the

benefits outweigh the costs, it will be less expensive in the long run. For a smart antenna to have pattern-adaptive capabilities and reasonable gain, an array of antenna elements is necessary [3].

3.4 Beamforming

Using multiple antennas in a receiver can reduce the effects of co-channel interference, multipath fading and background noise. An array forms an improved estimate of the desired signal by weighting and summing the signals received at multiple spatially separated antennas. By appropriately selecting the weights, high gain can be placed in the direction of a desired signal and low gain can be placed in the direction of interfering signals. This process is often referred to as beam forming or spatial filtering [7]. The weighting applied to the signals received at each antenna may be fixed or may be continuously adjusted to track changes in the signal environment. Beamforming creates the radiation pattern of the antenna array by adding the phases of signals in the desired direction and by nulling the pattern in the unwanted direction. The phases (the inter-element phases) and usually amplitudes are adjusted to optimize the received signal.

Beamforming (a signal processing technique) in which the directionality of an array of transducers, either transmitting or receiving, may be controlled electronically by using fixed or adaptive beam pattern. In beamforming we can project the majority of signal energy transmitted from a group of transducers in a desired angle of interest. Or we can adjust our group of transducers so that it can receive maximum energy at the desired angle [2].

Beamforming is the term used to describe the application of weights to the inputs of an array of antennas to focus the reception of the antenna array in a certain direction, called the look direction or the main lobe. More importantly, other signals of the same carrier frequency from other directions can be rejected [2]. These effects are all achieved electronically and no physical movement of the receiving antennas is necessary. In addition, multiple beam formers focused in different directions can share a single antenna array one set of antennas can service multiple calls of the same carrier.

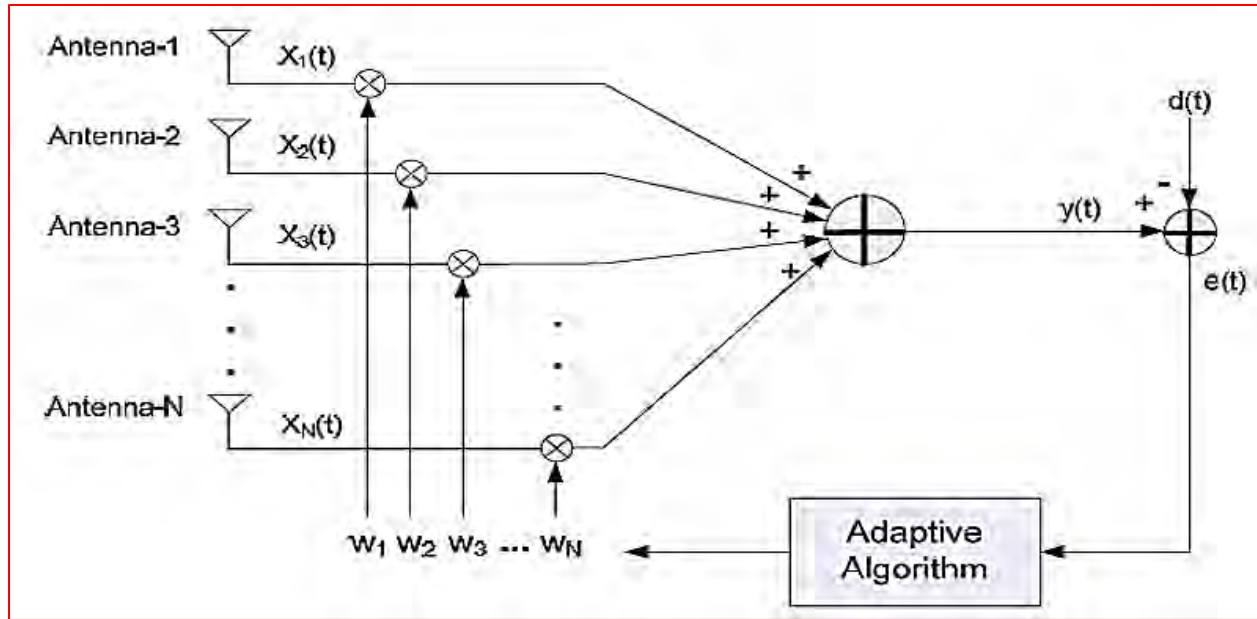

Figure 3.5 Adaptive beamforming algorithms [8]

Beamforming or spatial filtering is signal processing technique used in sensor arrays for directional signal transmission or reception. This can be achieved by combining the elements in phased array. A phased array is antenna array in which the relative phases of the respective signals feeding the antennas are varied in such a way that the effective radiation pattern of the array is reinforced in a desired direction and suppressed in undesired directions. In such a way that the signals at particular angles experience constructive while others experience destructive interference. Beamforming is the term used to describe the application of weights to the inputs of an array of antennas. Beamforming can be used at both the transmitting and receiving ends in order to achieve spatial selectivity [2].

Beamforming takes benefit of the interference to change the directionality of the array. For a transmission, a beam former controls the relative amplitude and phase of the signal at each transmitter; in order to create a pattern of constructive and destructive interference in the wave front. At the time of the reception, the information coming from different elements are combined in order to observe the expected pattern of radiation [8].

3.4.1 Classification of Beamforming

Usually beamforming is classified into analog and digital beamforming.

3.4.3.3 Analog Beamforming

A method of analog beamforming in a wireless system including transceivers with multiple antennas, comprising the steps of performing an iterative beam acquisition process based on beam search training; and determining optimized transmit and receive beam forming vectors comprising phase weighting coefficients, based on the iterative beam acquisition process; where in each iteration includes estimating the receive and transmit beam forming coefficients alternatively, until the receive and transmit beamforming coefficients converge.

3.4.3.4 Digital Beamforming

In DBF, the operations of amplitude scaling, phase shifting and summation for reception of signals is done digitally for each antenna element. General purpose DSP chips are used for this purpose. A/D convertor is used for the processing of digital signal for each antenna element. As the radio signals of more than short wave frequencies (> 30 MHz) are too high to be directly digitized at a reasonable cost, it uses 'RF translators' to shift downwards the frequency of the signal before A/D conversion.

Now the digitized signal of each antenna element is passed to digital-down-convertor. This will change the central frequency of the radio operator channel up to 0 Hz and passes only the bandwidth necessary for a channel. The down conversion of frequency produces a "quadrature" baseband at a low sampling rate.

3.4.2 Types of Beamforming

The weighting applied to the signals received at each antenna may be fixed (fixed or conventional beamforming) or may be continuously adjusted to track changes in the signal environment (adaptive or switched beamforming) [9].

In fixed beamforming multiple beams are formed by using a fixed weight matrix. The undesired signals which are leaking into the beam are suppressed by the interference canceling stage. The desired signal is filtered out by the fixed beamforming structure. Interfering signals will also be present in this beam due to the side-lobes. These interferers can be cancelled by using two alternate techniques. One of these two techniques is to use the other beam former outputs as inputs to an adaptive interference canceller; and the second one is to regenerate the outputs from the other beam former outputs and generate clean signals which are used as inputs to adaptive interference cancellers.

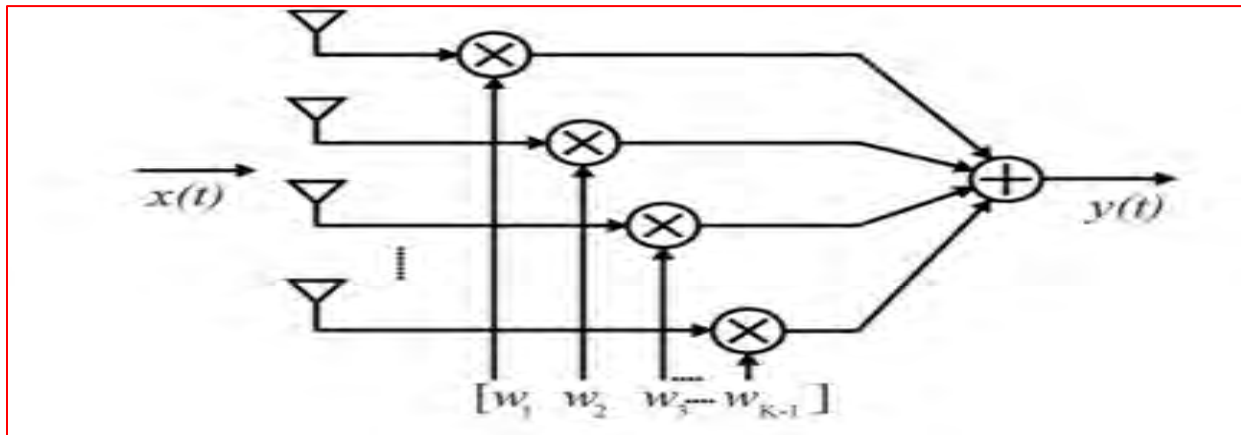

Figure 3.6 Beamforming algorithms [11]

The basic objective of a beam former is to adjust the complex weights at the output of each array element so as to produce a pattern that optimizes the reception of a target signal along the direction of interest, in some statistical sense [7].

3.4.3 Criteria for Optimal Beamforming

3.4.3.1 Minimum Mean-Square Error

In this method of optimizing the array weights, the shape of the desired received waveform is known by the receiver. Complex weights are adjusted to minimize the Mean Square Error (MSE) between the beam former output and the expected signal waveform. The output of the array is given as [7]

$$y = W^H X(t) \tag{3.1}$$

The error signal will be

$$\epsilon(t) = d(t) - W^H X(t) \quad (3.2)$$

where the reference $d(t)$ is signal, and $W^H X(t)$ is the array output. Then mean square error (MSE) is given by [8]

$$\epsilon^2(t) = [d(t) - W^H X(t)]^2 \quad (3.3)$$

Taking expectation on both side

$$E[|\epsilon^2(t)|] = E\{|d(t) - W^H X(t)|^2\} \quad (3.4)$$

$$E[|\epsilon^2(t)|] = E\{[d^2(t)]\} - 2W^H E[d(t)X(t)] + E[W^H X(t)]$$

$$E[|\epsilon^2(t)|] = E\{[d^2(t)]\} - 2W^H r + W^H R_{xx} W \quad (3.5)$$

where,

$$r = E\{[d(t)X(t)]\} \quad (3.6)$$

$$R_{xx} = E[XX^H] = R_{ss} + R_{uu} \quad (3.7)$$

where r is the cross correlation matrix between the desired signal and the received signal. R_{xx} is the auto correlation matrix of the received signal, and R_{ss} is the source (desired signal) correlation matrix, and R_{uu} is the undesired (noise) signal correlation matrix. The minimum MSE can be obtained by taking the gradient of the MSE with respect to the weight vectors and equating it to zero [7].

$$\nabla_W (E[|\epsilon^2(t)|]) = 2R_{xx}W - 2r = 0 \quad (3.8)$$

Therefore the optimum solution for the weight vector W is given by

$$W_{MSE} = R_{xx}^{-1}r \quad (3.9)$$

3.4.3.2 Maximum Signal- to-Interference Ratio

In this method of optimizing the array weights, the receiver can estimate the strength of the desired signal and of an interfering signal, and weights are adjusted to maximize the ratio. The weight array output power for the desired signal is given as [7]

$$\sigma_s^2 = E[|W^H X_S(t)|^2] = W^H R_{SS} W \quad (3.10)$$

Also the weight array output power for the undesired signal is

$$\sigma_u^2 = E[|W^H U(t)|^2] = W^H R_{uu} W \quad (3.11)$$

The Signal-to-Interference Ratio (SIR) is defined as the ratio of the desired signal power to the undesired signal power.

$$SIR = \frac{\sigma_s^2}{\sigma_u^2} = \frac{W^H R_{SS} W}{W^H R_{uu} W} \quad (3.12)$$

The maximum SIR can be obtained by taking the derivative with respect to W and setting the result equal to zero.

$$R_{uu}^{-1} R_{SS} W = SIR \cdot W \quad (3.13)$$

The maximum SIR is equal to the largest Eigen value for the Hermitian matrix $R_{uu}^{-1} R_{SS}$. And the Eigen vectors associated with the largest Eigen value is the optimum weight vector W_{opt} .

$$R_{uu}^{-1} R_{SS} W_{SIR} = \lambda_{max} W_{opt} = SIR_{max} W_{SIR} \quad (3.14)$$

$$W_{SIR} = \beta R_{uu}^{-1} \alpha_0 \quad (3.15)$$

, Where $\beta = E\{|S|^2\}$

3.4.3.3 Minimum Variance

In this method of optimizing the array weights, the signal shape and source direction are both known, the weights are then selected to minimize the noise on the beam former output.

From the weighted array output given as [7]

$$y = W^H X(t) = W^H \alpha_0 S + W^H U \quad (3.16)$$

To ensure a distortion less response then $W^H \alpha_0 = 1$, therefore

$$y = W^H X(t) = S + W^H U. \quad (3.17)$$

Taking the expectation on both sides assuming that the unwanted signal has zero mean, $E[y] = S$

The Variance of y is given as [7]

$$\sigma_{MV}^2 = E[|W^H X|^2] = E[|S + W^H U|^2] = W^H R_{uu} W \quad (3.18)$$

The Variance can be minimized by setting the gradient of a cost function equal to zero. The cost function is given as

$$\nabla_W J(W) = R_{uu} W_{MV} - \lambda \alpha_0 = 0 \quad (3.19)$$

Hence the minimum Variance optimum weights can be obtain by

$$W_{MV} = \lambda \alpha_0 R_{uu}^{-1} \quad (3.20)$$

Fixed weight beamforming systems are subject to degradation by various causes. The array SNR can be severely degraded by the presence of unwanted interfering signals, electronic countermeasures, clutter returns or multipath interference and fading. If the arrival angles of the emitters do not change with time, the optimum array weights would not need to be adjusted. However, if the desired arrival angles change with time, it is necessary to use adaptive algorithm that will update and compensate the array weight iteratively in order to track the desired user in the changing environment [7].

Chapter 4

4 Adaptive Beamforming Algorithm

4.1 Adaptive Beamforming

An adaptive beam former is a system of signal processing which is often used with a network of radar antennas (or phased array) with electronic steering to transmit/receive signals in desired directions, without having to direct the array mechanically. The principal distinction between adaptive beam former and a traditional beamforming is the capacity of the former to adjust its performances according to differences in its environment. A particularly important element in the military applications is the possibility of adaptive beam former to reduce the sensitivity in certain directions of arrival in order to counteract the hostile transmissions of jamming [13].

Block diagram of adaptive antenna system shown below Figure 4.1. Adaptive beam forming is a commonly employed technique that enables system operation in an interference environment by adaptively modifying the System's antenna pattern so that nulls are generated in the angular locations of the interference sources. This approaches applicable to scenarios where multiple antenna elements are individually weighted to produce a desired directivity pattern. In certain applications the gain of a single antenna may not sufficient.

Adaptive beam forming can be performed in many ways using adaptive algorithms. Most of the algorithms are concerned with the maximization of the SNR [7]. Adaptive array systems can locate and track signals (users and interferers) and dynamically adjust the antenna pattern to enhance reception, while minimizing interference using signal processing algorithms.

After the system down converts the received signals are again convert in to baseband and digitizes them, it locates the signal of interest (SOI) using the DOA algorithm, it continuously tracks the SOI and signal not of interest (SNOI)s by dynamically changing the weights (amplitudes and phases of the antenna elements). Basically the DOA computes the direction-of-arrival of all signals by computing the time delays between the antenna elements. Adaptive arrays are generally more digital processing intensive and require a

complete RF portion of the transceiver behind each antenna element; they tend to be more expensive than switched-beam systems

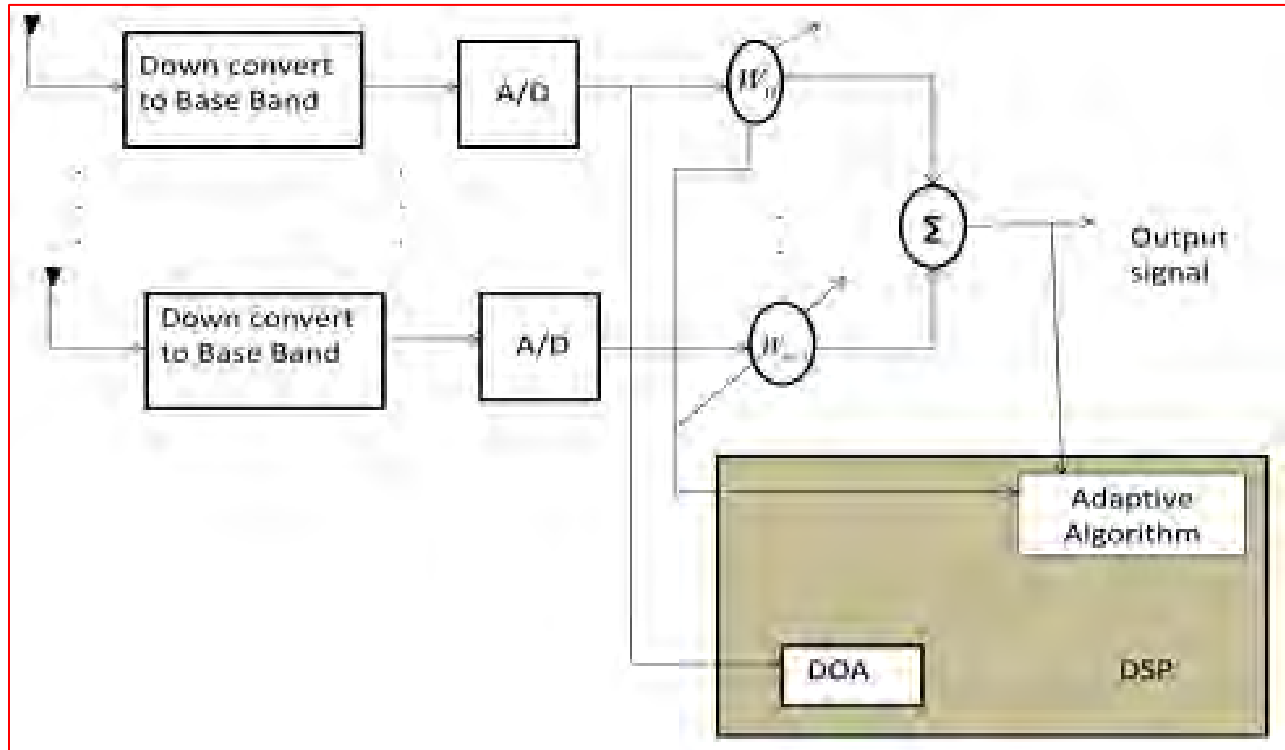

Figure 4.1 Block diagram of adaptive antenna system [7]

In an ever-changing propagation environment, such as in a mobile cellular network, where the arrival angles of the emitters change continuously with time, fixed beamforming becomes ineffective[7]. In such environment adaptive beamforming is used to overcome the problems of fixed beam forming. Adaptive beamforming combines the inputs of multiple antennas (from an antenna array) to form very narrow beams toward individual users in a cell. An adaptive beam former is a device that is able to separate signals collocated in the frequency band but separated in the spatial domain. This provides a means for separating a desired signal from interfering signal. An adaptive beam former is able to automatically optimize the array pattern by adjusting the elements control weights until a prescribed objective function is satisfied. The means by which the optimization is achieved is specified by an algorithm designed for that purpose.

The digital signal processor interprets the incoming data information, determines the complex weights (amplitude and phase information) and multiplies the weights to each element output to optimize the array pattern. From the figure above the output response of the uniform linear array is given as,

$$y(t) = W^H X(t) \quad (4.1)$$

where, W is the complex weight vector and X is the received signal vector.

The complex weights vector is obtained using an adaptive beamforming algorithm. Adaptive beamforming algorithms are classified as Direction of Arrival (DOA) based, temporal-reference-based or signal structure-based. In DOA-based beamforming, the direction of arrival algorithm passes the DOA information to the beam former. The beamforming algorithm is then used to form radiation patterns, with the main beam directed towards the signal of interest and with nulls in the directions of the interferers. On the other hand, temporal-reference-based beamforming uses a known training sequence to adjust the weights and to form a radiation pattern with a maximum towards the signal of interest [7]. If $d(t)$ denotes the referenced sequence or the training symbol known a priori at the receiver at time t , an error ϵ is formed as

$$\epsilon(t) = d(t) - W^H X(t) \quad (4.2)$$

This error signal is used by the beam former to adaptively adjust the complex weights vector, so that the Mean Square Error (MSE) is minimized. The choice of weights that minimize the MSE is such that the radiation pattern has a beam in the direction of the source that is transmitting the reference signal, and that there are nulls in the radiation pattern in the directions of the interferers.

4.2 Adaptive Beamforming Algorithm

According to whether a training signal is used or not, most of the adaptive beamforming algorithms can be classified into non-blind adaptive algorithm and blind adaptive algorithm. Non-blind adaptive algorithms uses reference signal to modify the array weights repetitively, so that at the end of each & every iteration the output of the weights is

compared to the reference signal and the generated error signal is used in the algorithms to modify the weights. The examples are Least Mean Square Algorithm (LMS), Recursive Least Square algorithm (RLS), Sample Matrix Inversion (SMI) and Conjugate Gradient (CG). Blind adaptive algorithms do not make use of the reference signal and hence no array weight adjustment is required. The examples are Constant Modulus algorithm (CMA) and Least Square Constant Modulus (LS-CMA). By adaptively changing the antenna array pattern, nulls are formed in the angular locations of the interference sources so that adaptive beamforming technique is able to operate in an interference environment. The digital signal processor is the heart of adaptive beamforming, which interprets the incoming data, determines the complicated weights (amplification and phase information) and multiplies the weights to each element output and corrects the array pattern. The array thus minimizes the effect of noise & interference and produces maximum gain in the desired direction. Thus the smart antenna's efficiency and performance is dependent on the adaptive algorithms used for digital beam forming

4.2.1 LMS Algorithm

The Least Mean Square (LMS) algorithm uses a gradient based method of steepest decent. LMS incorporates an iterative procedure that makes successive corrections to the weight vector in the direction of the negative of the gradient vector which eventually leads to the minimum mean square error. LMS algorithm is relatively simple, it does not require correlation function calculation nor does it require matrix inversions. A very computationally efficient adaptive algorithm is the least mean squares (LMS) algorithm.

LMS is an iterative solution to solve for the weights which track to the bottom of the performance surface. The LMS algorithm estimates the gradient of the error signal, $e(n)$, by employing the method of steepest descent, which is summarized below [12].

Consider a Uniform Linear Array (ULA) with N isotropic elements, which forms the integral part of the adaptive beam forming system as shown in the figure. The output of array antenna $x(t)$ is given by equations [13].

$$x(t) = s(t)a(\theta_0) + \sum_{i=1}^{N_u} u_i(t)a(\theta_i) + n(t) \quad (4.3)$$

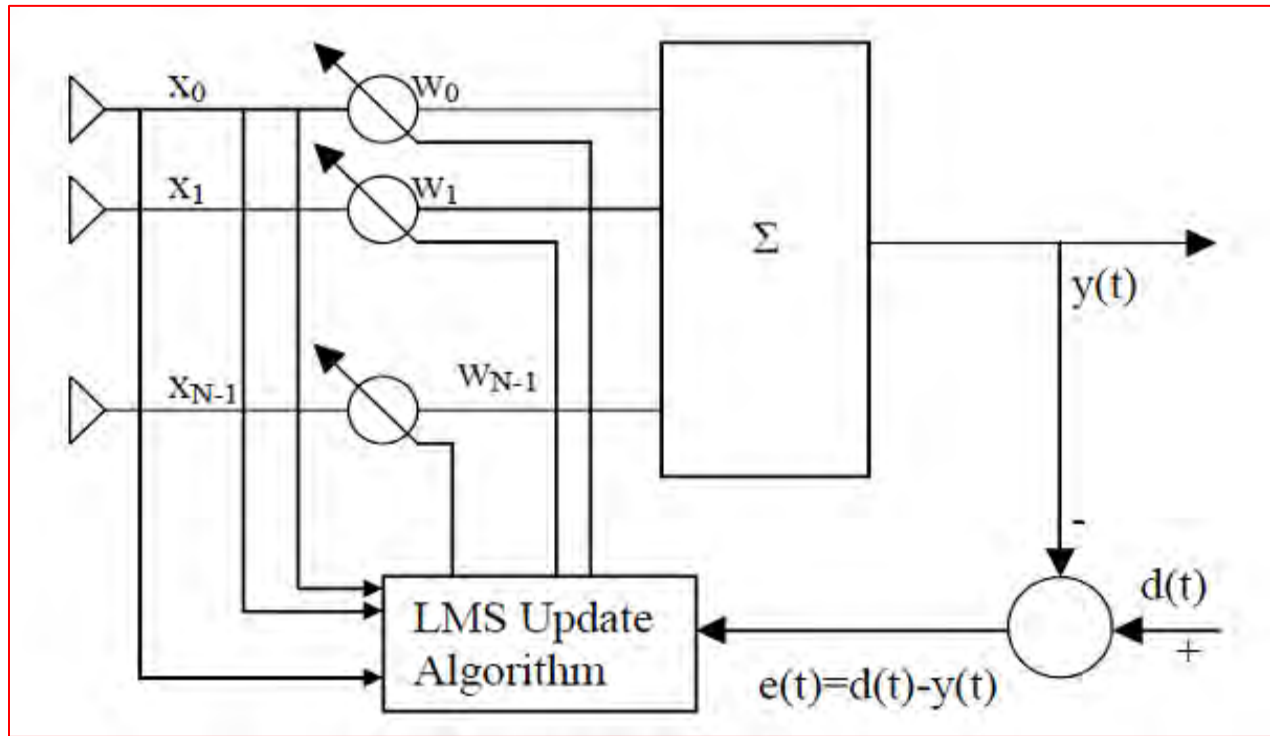

Figure 4.2 LMS algorithm [12]

Where $s(t)$ denotes the desired signal arriving at angle θ_0 and $u_i(t)$ denotes interfering signals arriving at angle of incidences θ_i respectively. $a(\theta_0)$ and $a(\theta_i)$ represents the steering vectors for the desired signal and interfering signals respectively. Therefore it is required to construct the desired signal from the received signal amid the interfering signal and additional noise $n(t)$. From the method of steepest descent, the weight vector equation [13] is given by

$$W(n+1) = W(n) + \frac{1}{2}\mu[-\nabla(E\{e^2(n)\})] \quad (4.4)$$

$$W(n+1) = W(n) + \mu X(n)[d^*(n) - X^H(n)W(n)] \quad (4.5)$$

$$W(n+1) = W(n) + \mu X(n)e^*(n) \quad (4.6)$$

Where μ is the step-size parameter and controls the convergence characteristics of the LMS algorithm $e^2(n)$ is the mean square error between the beam former output $y(n)$ and the reference signal which is given by

$$e^2(n) = [d^*(n) - W^H X(n)]^2 \quad (4.7)$$

The gradient vector in the above weight update equation can be computed as [13]

$$\nabla(E\{e^2(n)\}) = -2r + 2RW(n) \quad (4.8)$$

In the method of steepest descent the biggest problem is the computation involved in finding the values r and R matrices in real time [13]. The LMS algorithm on the other hand simplifies this by using the instantaneous values of covariance matrices r and R instead of their actual values i.e.

$$R(n) = X(n)X^H(n) \quad (4.9)$$

$$r(n) = d^*(n)X(n) \quad (4.10)$$

The LMS algorithm is initiated with an arbitrary value $w(0)$ for the weight vector at $n=0$. The successive corrections of the weight vector eventually leads to the minimum value of the mean squared error. The step size varies from 0 to max, where max is the largest Eigen value of the correlation matrix R .

Thus the LMS algorithm can be summarized in following equations.

Table 4.1 Summary of LMS equations

The output $y(n)$	$y(n) = W^H(n)X(n)$
Error $e^*(n)$	$e^*(n) = d^*(n) - X^H(n)W(n)$
Weight update $W(n+1)$	$W(n + 1) = W(n) + \mu X(n)e^*(n)$

The LMS algorithm is important because of its simplicity and ease of computation, because it does not require off-line gradient estimations or repetition of data. One of the drawbacks of the LMS adaptive scheme is that the algorithm must go through many iterations before satisfactory convergence is achieved. If the signal characteristics are rapidly changing, the LMS algorithm may not allow the tracking of the desired signal in a satisfactory manner. The rate of convergence of the weight is dictated by the Eigen value spread of the correlation matrix, given as [7].

$$0 < \mu < 1/\lambda_{max} \quad (4.11)$$

Where λ_{max} is the largest Eigen value of the correlation matrix R_{xx} .

The convergence of the LMS algorithm is directly proportional to the step-size parameter μ . If the step-size is too small, then the convergence will slow and have the over damped case. If the convergence is slower than the changing angles of arrival, it is possible that the adaptive array cannot acquire the signal of interest fast enough to track the changing signal. If the step-size is too large, the LMS algorithm will overshoot the optimum weights of interest. This is called the under damped case. If attempted convergence is too fast, the weights will oscillate about the optimum weights but will not accurately track the solution desired. It is therefore imperative to choose a step-size in a range that insures convergence. It can be shown that stability is insured provided that the following condition is met [9].

$$0 \leq \mu \leq 1/2\lambda_{max} \quad (4.12)$$

Since the correlation matrix is positive definite, all eigenvalues are positive. If all the interfering signals are noise and there is only one signal of interest then the above condition can be approximated as [9]

$$0 \leq \mu \leq 1/2\text{trace}[R_{xx}] \quad (4.13)$$

According to [14], considering case were desired user is arriving at an angle of 30 degree and an interfere user at an angle of -50 degree. The spacing between the individual elements is half wavelength and the signal to noise ratio (SNR) is 30db. The array factor for 8 element antenna array is computed. Figure below shows rectangular and polar array factor plot for different angle of arrival.

According to [8], by using linear antenna array of 20 elements and distance separation between elements of 0.5λ . They took angle of arrival of the desired user is at 45 degree and interfering user at 60 degree. The fig below shows the simulation result of their work and accordingly as expected at interfering user null and maximum radiation along desired user by increasing number of elements sharp beams will be formed. The optimum weight vector for N=20 elements is

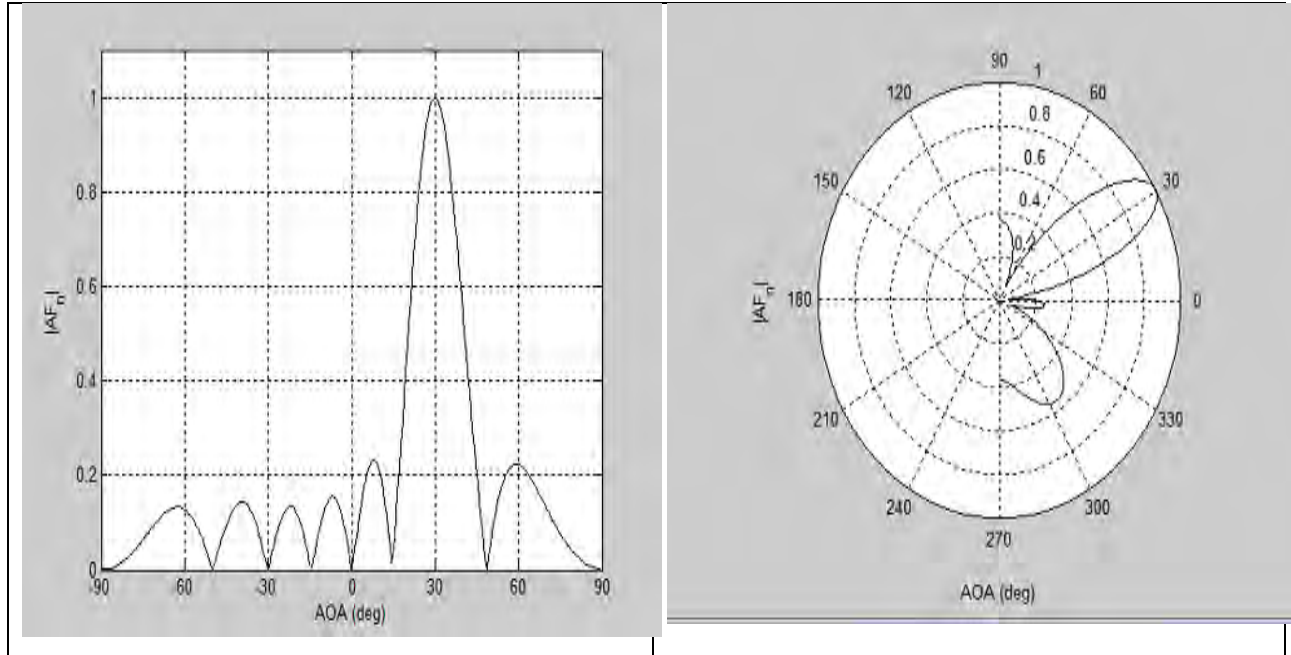

Figure 4.4.3 Rectangular and polar plot when desired users is at 30 degree and interfere is at -50 degree [14]

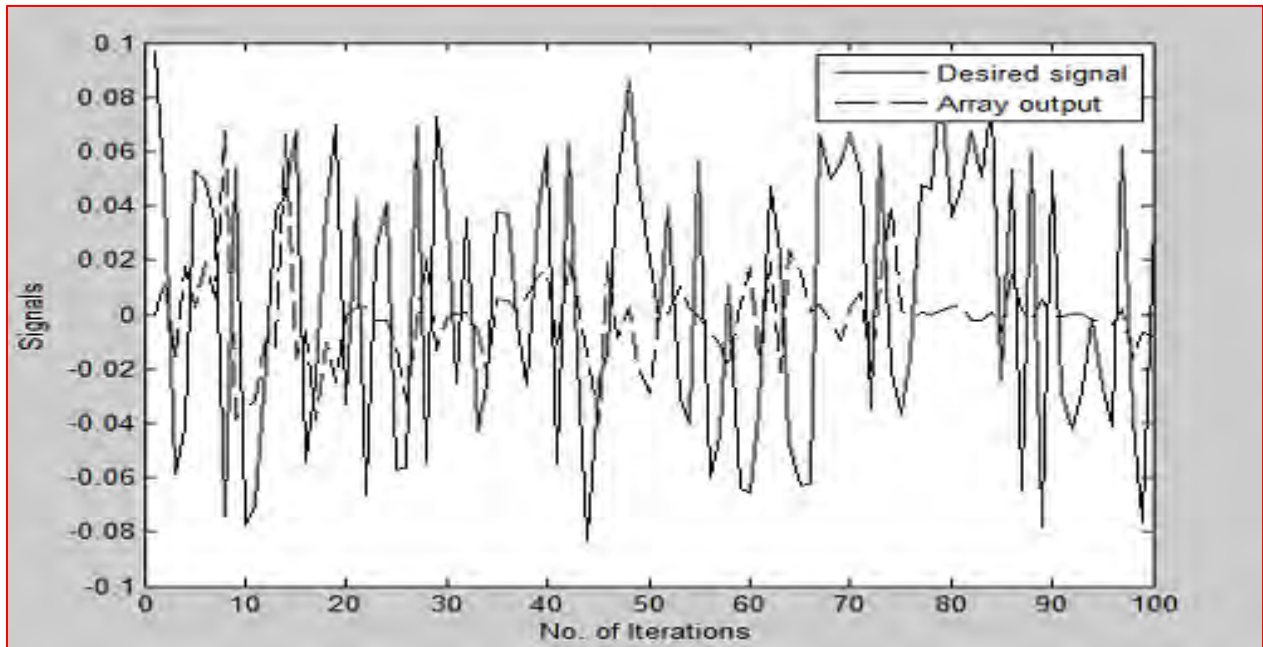

Figure 4.4 Array output and desired signal [14]

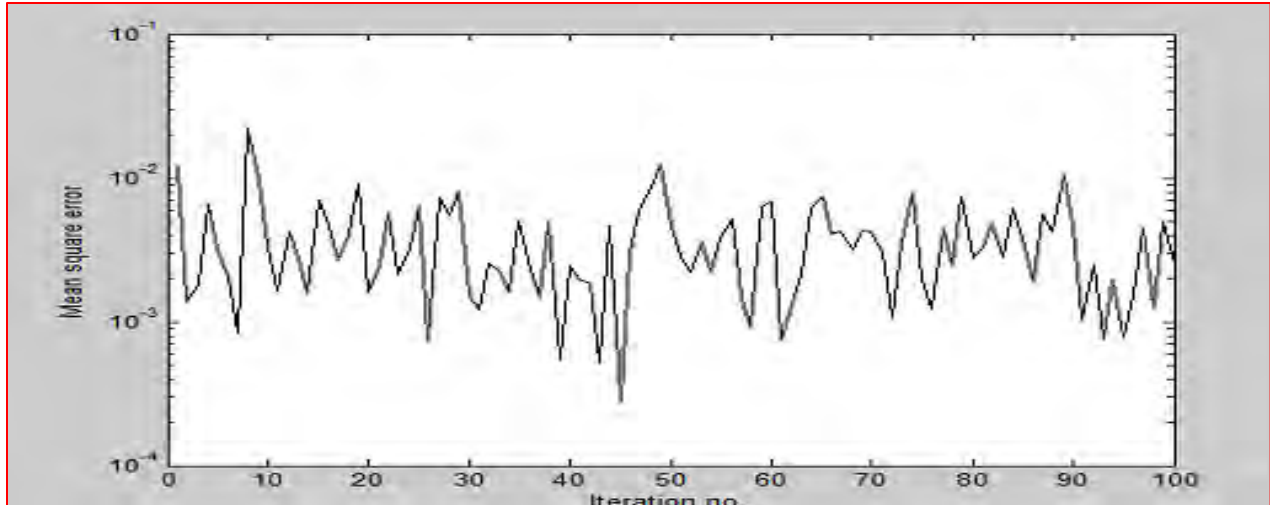

Figure 4.5 Mean square error vs iteration number [14]

Table 4.2 Optimum weight vector [13]

Element no	Weights
1	w1 = 1
2	w2 = -0.54681+0.72269i
3	w3 = -0.26776-0.78213i
4	w4 = 0.7693+0.16813i
5	w5 = -0.54804+0.58855i
6	w6 = -0.21553-0.84286i
7	w7 = 0.89401+0.35259i
8	w8 = -0.91231+0.52333i
9	w9 = 0.20811-1.1031i
10	w10 = 0.71059+0.91806i
11	w11 = -1.1579-0.084405i
12	w12 = 0.80401-0.78337i
13	w13 = 0.068438+1.0495i
14	w14 = -0.78814-0.54992i
15	w15 = 0.82145-0.2865i
16	w16 = -0.18733+0.78208i
17	w17 = -0.56548-0.54801i
18	w18 = 0.79974-0.2094i
19	w19 = -0.29978+0.85523i
20	w20 = -0.55297-0.8332i

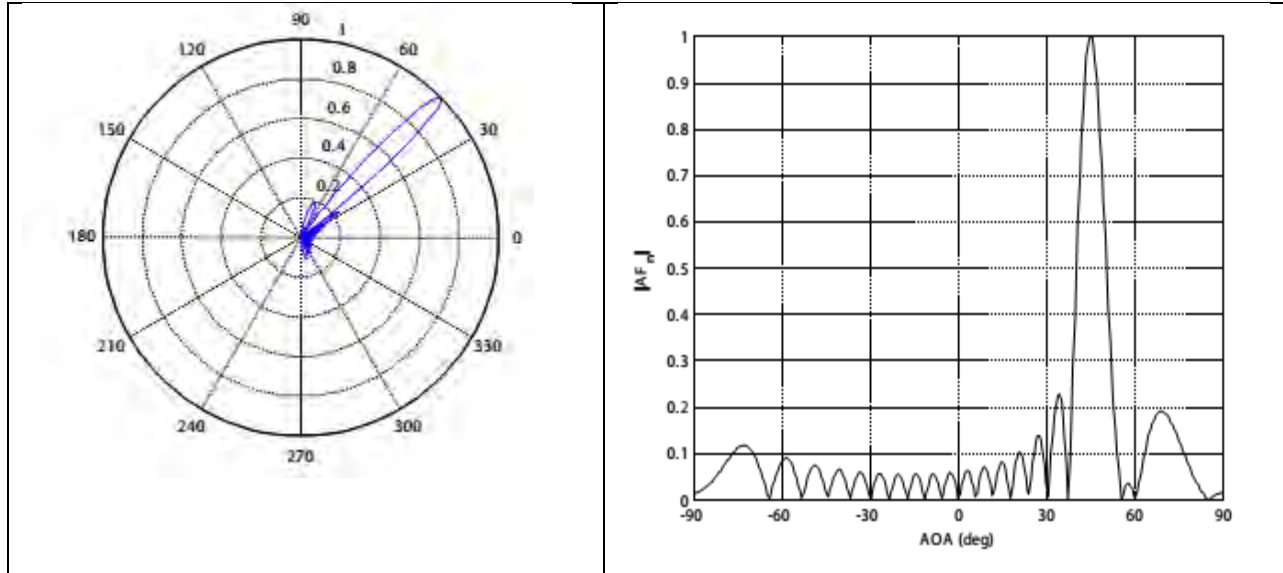

Figure 4.6 Polar and normalized array factor plot for N=20 [13]

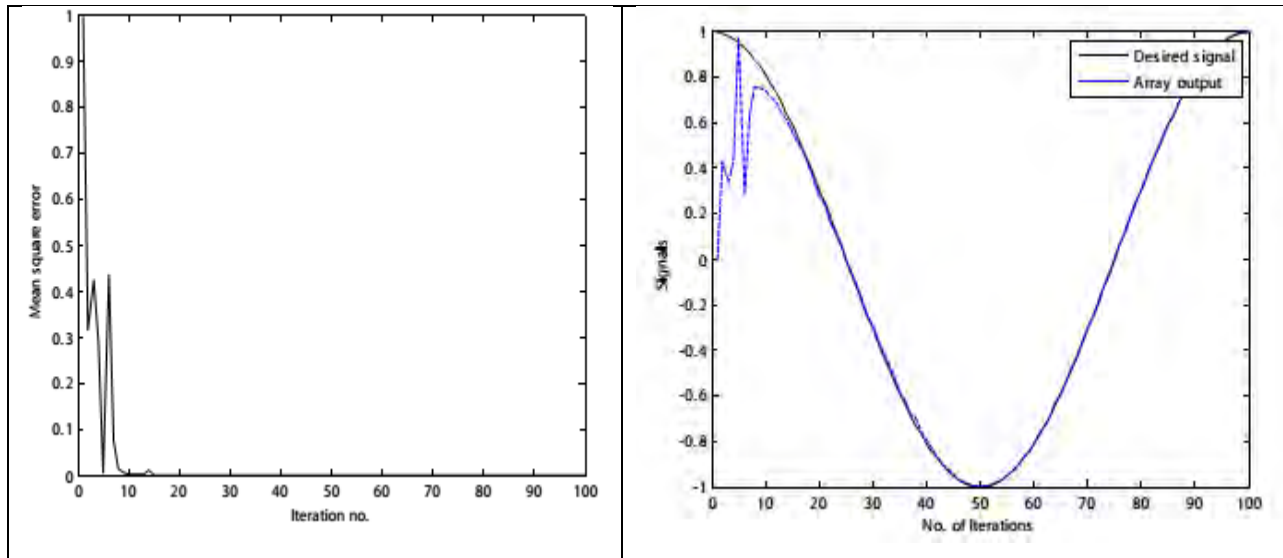

Figure 4.7 Mean square error vs iteration number and array output [13]

4.2.2 SMI (Sample Matrix Inversion) Algorithm

The Sample matrix inversion is also called as Direct Matrix Inversion (DIM) algorithm. Sample matrix is a time average estimate of the array correlation matrix using k-time samples. If the random process is ergodic in the correlation, the time average estimate will equal the actual correlation matrix. The drawbacks of LMS adaptive beam forming algorithm must go through many iterations before satisfactory convergence is achieved. If the signal characteristics are

rapidly changing, the LMS adaptive algorithm may not allow tracking of the desired signal in a satisfactory manner. The rate of convergence of the weights is dictated by the eigenvalue spread of the array correlation matrix. The LMS algorithm did not converge until after 70 iterations. 70 iterations corresponded to more than half of the period of the waveform of interest [13]. One possible approach to circumventing the relatively slow convergence of the LMS scheme is by use of SMI method.

The optimum Wiener solution is given as [7]

$$W_{opt} = R_{xx}^{-1}r \quad (4.14)$$

Thus the correlation matrix r is

$$r = E[d^* \cdot X] \quad (4.15)$$

Covariance matrix R is

$$R_{xx} = E[XX^H] \quad (4.16)$$

By taking time average (over observation interval K)

$$R_{xx}(k) = \frac{1}{K} \sum_{k=1}^k X(k)X^H(k) \quad (4.17)$$

The correlation vector r can be estimated by [8]

$$r(k) = \frac{1}{k} \sum_{k=1}^k d^*(k)X_k(k) \quad (4.18)$$

The K -length block of data is called a block adaptive approach uses the weights block-by-block. It is easy in mat lab to calculate the array correlation matrix and the correlation vector by the following procedure. Define the matrix $K(x)$ as the k th block of x vectors ranging over K -data snapshots. The SMI weights can then be calculated for the k th block of length K as [9], [13]

$$W_{SMI}(k) = R_{xx}^{-1}(k)r(k) \quad (4.19)$$

According to [13] SMI algorithm simulated by using linear array is used for simulation purpose that is 20 elements and distance separation between elements is 0.5. They used angle of arrival

of the desired user is at 30 degree and interfering user at 55 degree. They came up with the following results.

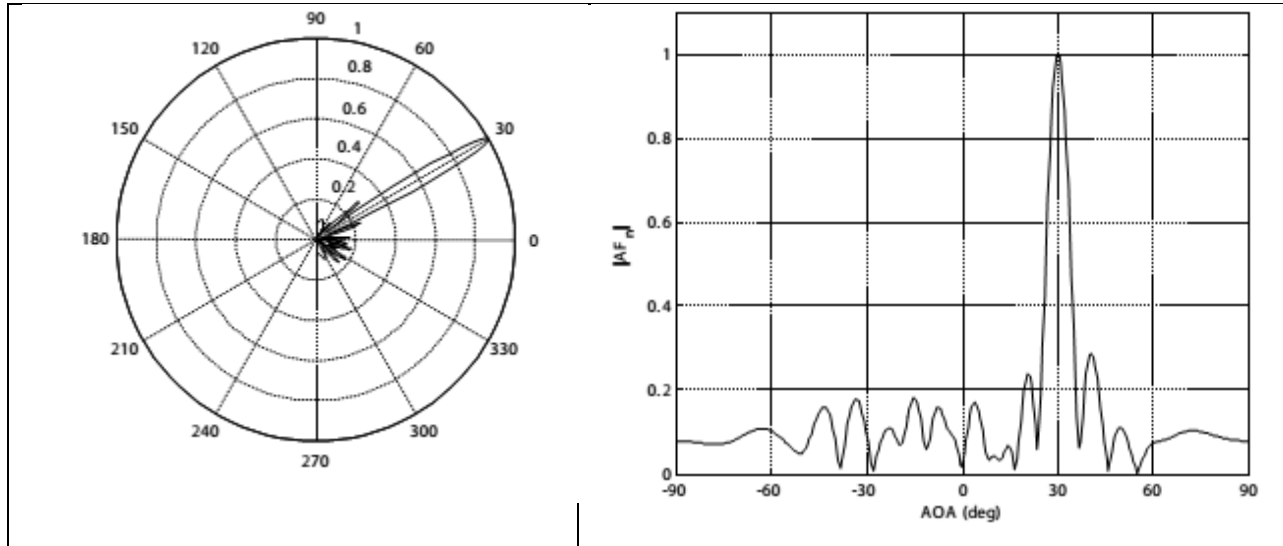

Figure 4.8 Polar plot and normalized array factor representation for SMI algorithm N=20 [13]

Table 4.3 Optimum weight vectors for SMI [13]

Element no	Weights
1	w1=1.0000
2	w2=0.5716-0.4195i
3	w3=-0.9084+ 0.0718i
4	w4=0.1730+0.5590i
5	w5=0.6855+0.2428
6	w6=0.1792-1.0187i
7	w7=0.6601+0.0279i
8	w8=0.0390+0.5469i
9	w9=0.5619+0.2631i
10	w10=-0.0763-0.6262i
11	w11=-0.9918-0.1182i
12	w12=-0.2338+0.5076i
13	w13=0.6703+0.0709i
14	w14=-0.2325-0.9776i
15	w15=-0.8954 0.5556i
16	w16=0.0671+1.0477i
17	w17=0.8839+0.2721i
18	w18=-0.0053 - 0.7281i
19	w19= -0.5897 + 0.0848i
20	w20= -0.0836 + 0.4757i

e = 1.0021 - 0.0029i.

4.2.3 RLS algorithm

The Recursive Least Square (RLS) algorithm was developed to solve the problem of slow convergence speed in an environment yielding an array correlation matrix with large Eigen value spread. This is achieved by making its convergence independent of the Eigen values distribution of the correlation matrix [7]. Even though the SMI method is faster than the LMS algorithm, the computational burden and potential singularities can cause problems. However, we can recursively calculate the required correlation matrix and the required correlation vector [9].

$$R_{xx}(k) = \frac{1}{K} \sum_{i=1}^k X(i)X^H(i) \quad (4.20)$$

$$r(k) = \frac{1}{k} \sum_{i=1}^k d^*(i)X_k(i) \quad (4.21)$$

Both summations in above equation use rectangular windows, thus they equally consider all previous time samples. Since the signal sources can change or slowly move with time, we might want to deemphasize the earliest data samples and emphasize the most recent ones. This can be accomplished by modifying above equation such that we forget the earliest time samples. This is called a weighted estimate [9].

$$R_{xx}(k) = \sum_{i=1}^k \alpha^{k-i} X(i)X^H(i) \quad (4.22)$$

$$r(k) = \sum_{i=1}^k \alpha^{k-i} d^*(i)X_k(i) \quad (4.23)$$

Where α , the forgetting factor or the exponential weighting factor is a positive constant such that $0 \leq \alpha \leq 1$. When $\alpha=1$, we restore the ordinary least squares algorithm. $\alpha=1$ also indicates infinite memory.

$$R_{xx}(k) = \alpha \sum_{i=1}^{k-1} \alpha^{k-1-i} X(i)X^H(i) + X(k)X^H(k) \quad (4.24)$$

$$= \alpha R_{xx}(k-1) + X(k)X^H(k)$$

$$r(k) = \alpha \sum_{i=1}^{k-1} \alpha^{k-1-i} d^*(i)X_k(i) + d^*(k)X_k(k) \quad (4.25)$$

$$= \alpha r(k-1) + d^*(k)X_k(k)$$

The advantage of the recursion approach is that one need not calculate the correlation for an entire block of length K. Rather, each update only requires one a block of length 1 and the previous correlation matrix [9].

In RLS algorithm, the weights are updated using the equation below,

$$W(k) = W(k-1) + G(k)e^*(k) \quad (4.26)$$

Where G(k) is the gain vector and $e(k)$ is prior estimation error which is given as

$$G(k) = R_{xx}^{-1}(k)r(k) \quad (4.27)$$

$$e(k) = d(k) - W^H(k-1)U(k) \quad (4.28)$$

The RLS algorithm does not require any matrix inversion computations as the inverse correlation matrix is computed directly. It requires reference signal and correlation matrix information. An important feature of the RLS is that its rate of convergence is typically an order of magnitude faster than that of the LMS algorithm, due to the fact the RLS algorithm convergence is independent of the Eigen values distribution of the correlation matrix. This improvement however is achieved at the expense of an increase in the computational complexity of the Recursive Least Square algorithm[7].

The Adaptive Beam forming using RLS algorithm consists of multiple antennas and complex weights, the function of which is to amplify (or attenuate) and delay the signals from each antenna element and a summer to add all of the processed signals, in order to tune out the signals of interest. The output response of the uniform linear array is given by

$$Y(n) = W^H(n-1)X(n) \quad (4.29)$$

According to [13] by using uniform linear array with (N = 20) number of elements is considered. The inter-element spacing is considered to be half wavelength. It is considered that the desired user is arriving at an angle of 30 degrees and an interferer at an angle of -30 degrees. The Matlab simulation results are shown as below.

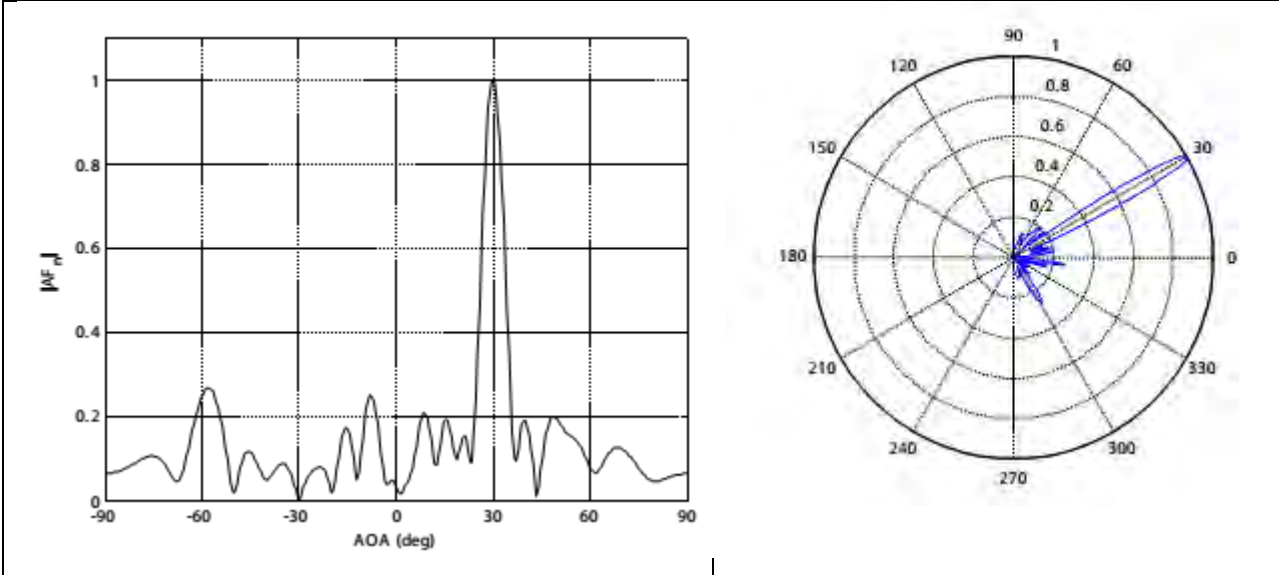

Figure 4.9 Simulation result for RLS [13]

Chapter 5

5 Simulation Results and Discussions

In this Chapter, simulation set-up and simulation results for adaptive beamforming algorithms have been shown. Array parameters (spacing between array elements, number of array) and adaptive beamforming algorithms which are described in Chapter 4 are programmed in Matlab and simulations are performed to obtain array pattern, sidelobes level and nulling. These performance characteristics are used to compare the performances of the different adaptive beamforming algorithms such as: RLS, LMS and SMI. There are also simulations included to compare the mean square error and speed of convergence.

In this thesis a uniform linear array of different number and length of spacing located at the base station are considered to perform spatial filtering. The weights of the adaptive beamforming algorithms are adjusted using the training signal (the pilot signal) and the channel is assumed to be flat fading channel. What is required from smart antenna system is that to steer the main beam in the desire direction, minimum power in the jammer location and minimum side lobe level by adjusting the complex weight.

Simulation assumptions and parameters

Table 5.1 Simulation parameters and assumptions

K (number of iteration) for LMS	100 and 200
M (block size) for SMI	100
α (forget factor)	0.9
SNR , INR	10 dB
Step size(convergence factor)	$\mu = 1/(4*\text{real}(\text{trace}(\mathbf{R}_x)))$
Uniform spacing between array elements are used	
Channel is assumed to be flat fading channel	
Users and interferers angle of arrival is assumed to be known	

5.1 Simulation Result for Single Interferer

In this section all the adaptive beamforming algorithms are done for 8 array elements and two users, where the desired user is located at 0° and the interferer is located at 45° . Figure 5.1 is plotted using LMS and accordingly the normalized array pattern at desire direction (0°) is 0 dB and the value in the undesired location (45°) is around -46.02 dB which is close to zero, and this is required in the smart antenna system for beam steering and interference mitigation. The side lobe (maximum) level is -12.39dB (-21°) and -13.35dB (21°) which is much smaller than the main beam.

The first null value which is located at -14.4° and 14.7° are -38.41 dB and -34.89 dB respectively. Moreover, on the simulation output, the solid line positions infer to the position of intended user and the locations of the dashed lines correspond to the locations of the interferers.

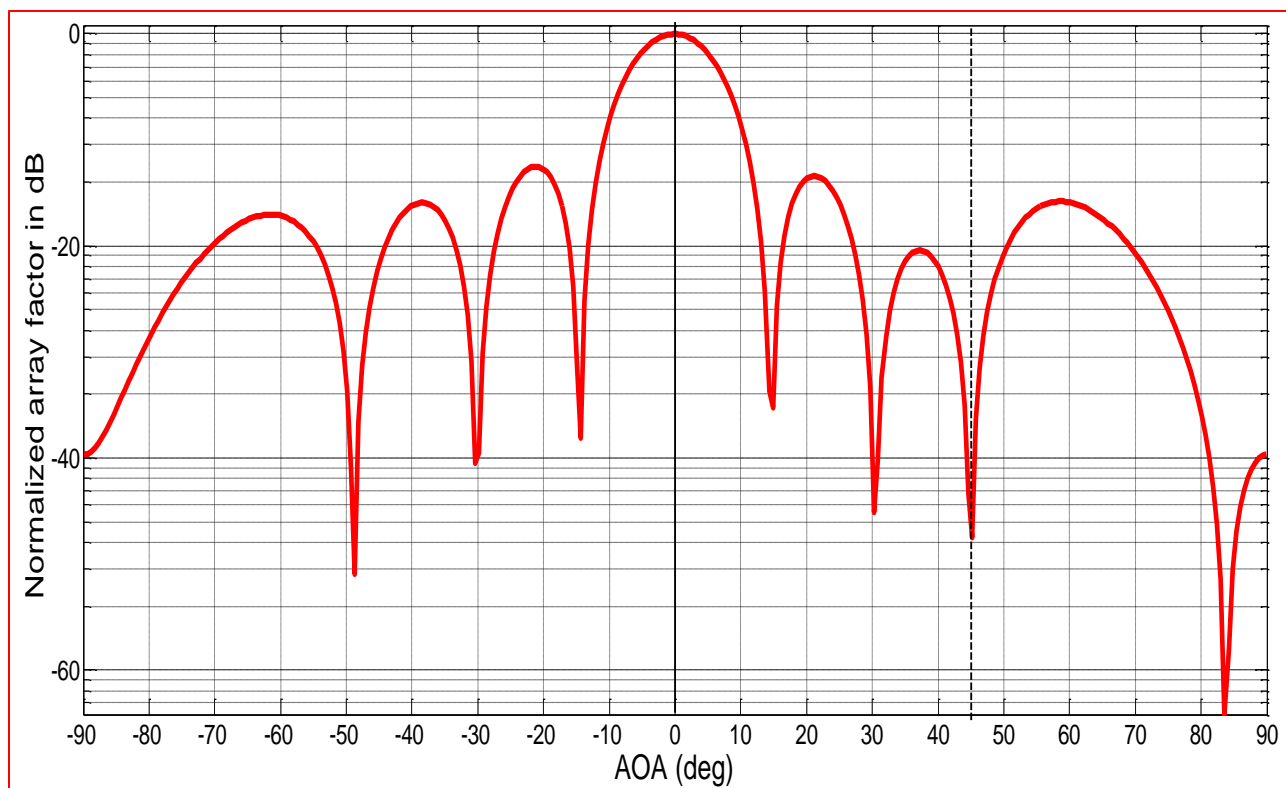

a) Radiation pattern rectangular plot in dB

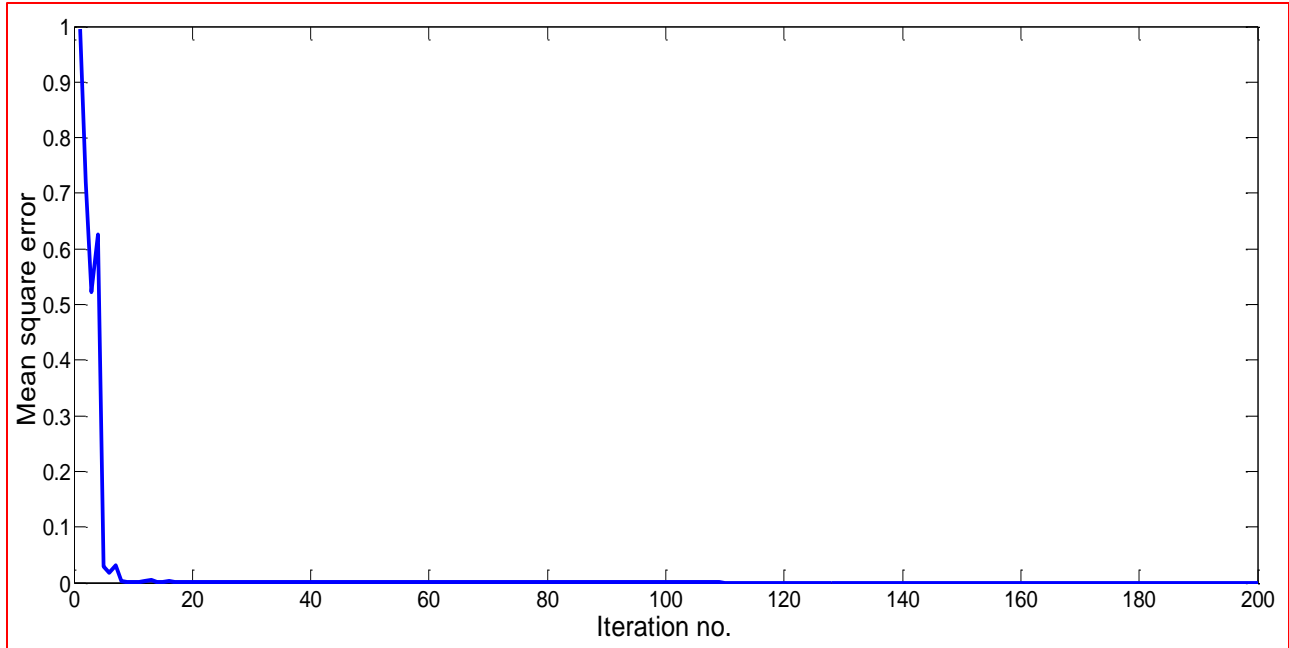

b) Plot of mean square error

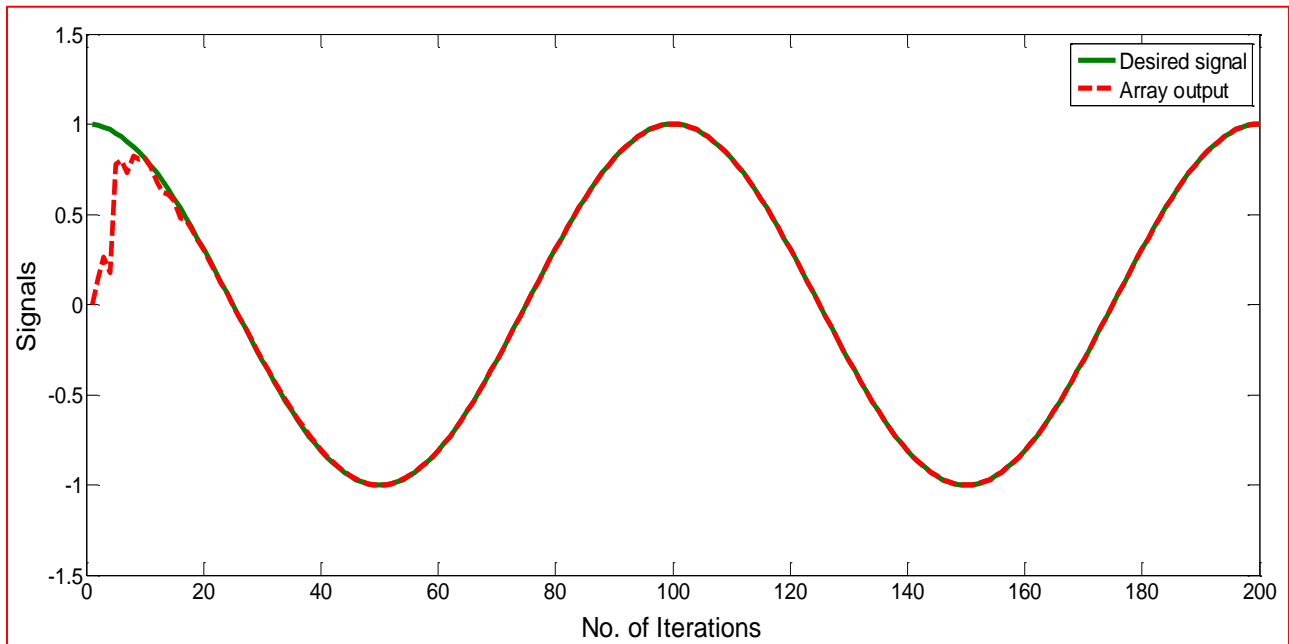

c) Desired signal vs array output

Figure 5.1 Simulation results of radiation pattern, MSE and array output, using LMS ($d=0.5\lambda$, $N=8$ and arrival angle of 0° for user and 45° for interferer).

As shown in Figure 5.2 normalized array factor at desire direction (0°) is 0 dB and the value in the undesired location (45°) is -41.17 dB, which is satisfactory performance in placing deep null towards interferer position. Maximum side-lobe level values are -9.37dB (20°) and -9.62dB (-20°). Nulling of value -23.34dB and -20.26 dB located at -12.6° and -12.5° respectively.

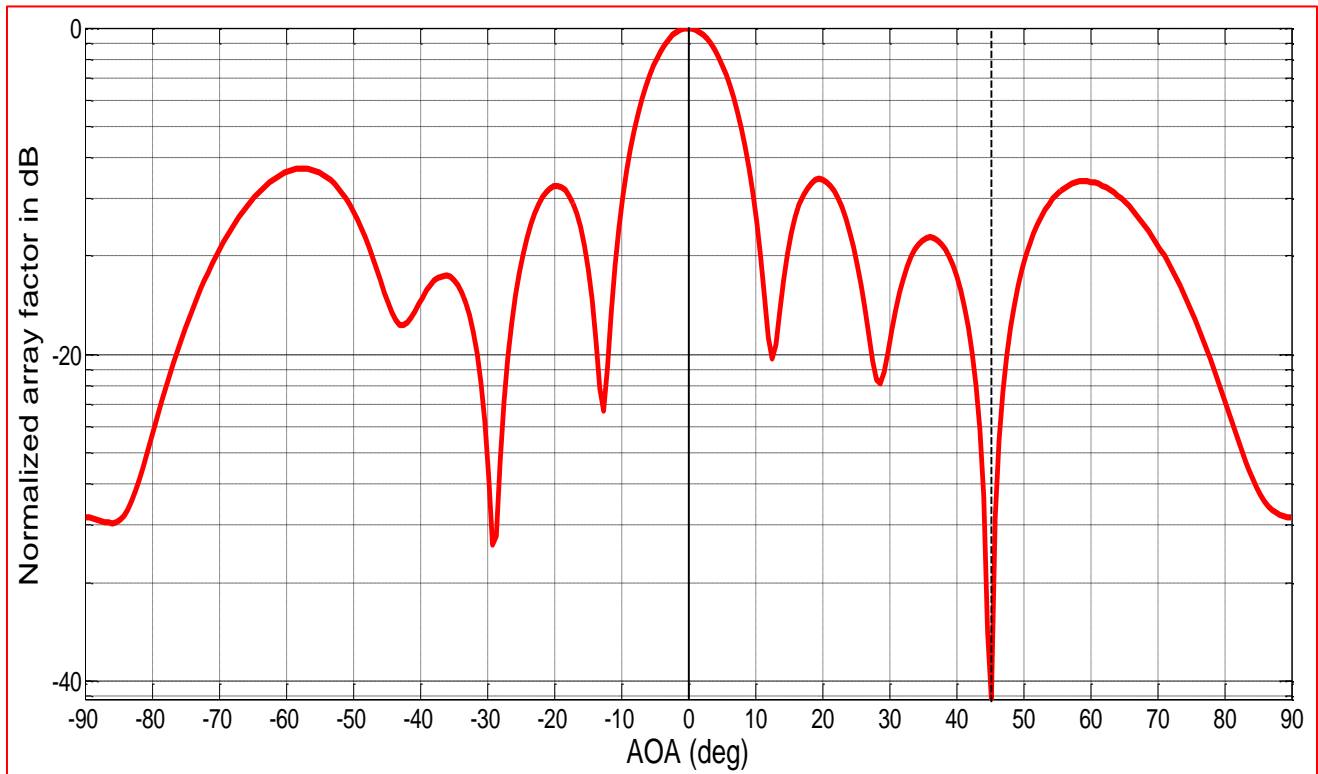

Figure 5.2 Simulation results of radiation pattern, using SMI ($d=0.5\lambda$, $N=8$ and arrival angle of 0° for user and 45° for interferer)

Figure 5.3 shows simulation results using and accordingly the value of normalized beam pattern in the intended user location (0°) is 0dB and in the interferer location (45°) is 43.21dB. Thus RLS algorithm has satisfactory performance in nulling the interference source as well as in making main lobe towards the intended user. In addition, side lobe (maximum) level of value -12.58dB and -11.18dB is obtained respectively at -22° and 21.5° .

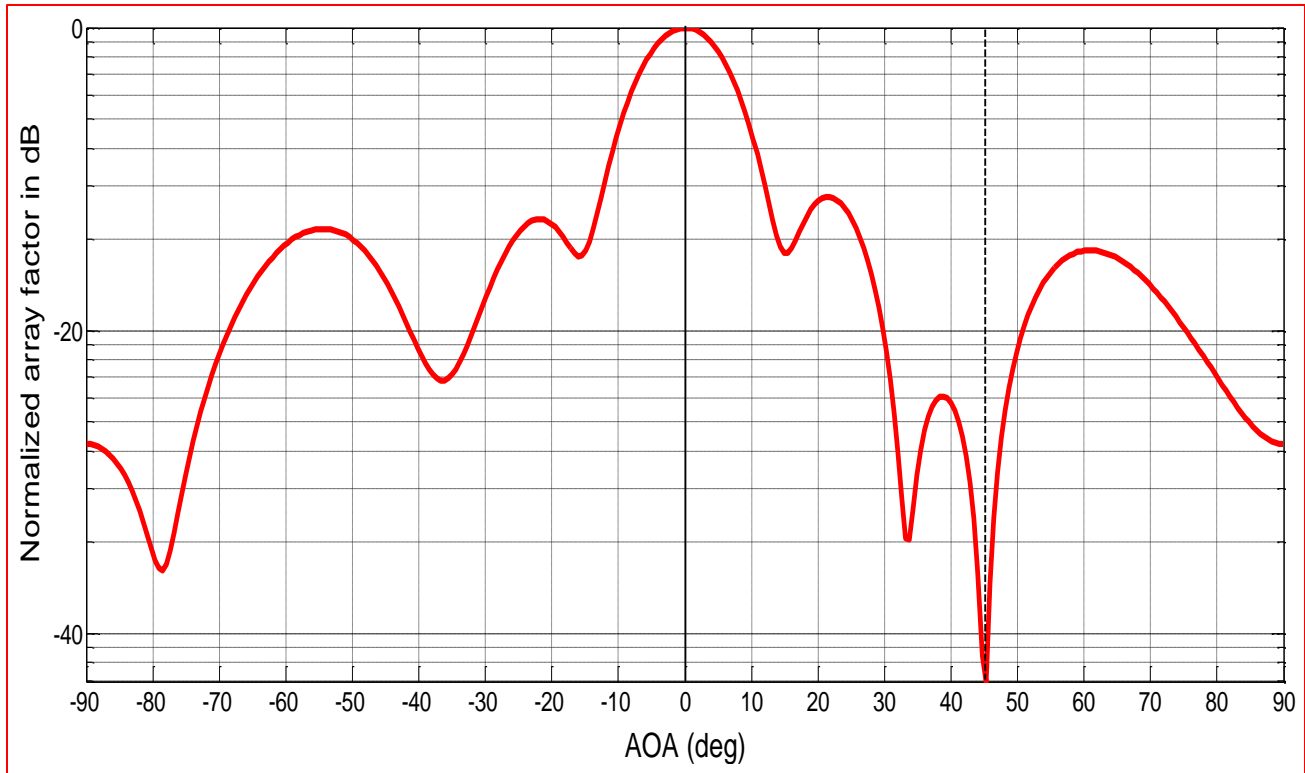

Figure 5.3 Simulation results of radiation pattern, using RLS ($d=0.5\lambda$, $N=8$ and arrival angle of 0° for user and 45° for interferer)

As shown on Figure 5.4 the entire adaptive beam forming algorithm works well making main lobe, which for all cases are 0dB towards the intended user. LMS algorithm performs better in nullifying signal in undesired direction than others. And also when their side-lobe levels are compared LMS have low side-lobe level than others and SMI has side-lobe level which is almost comparable to the main lobe. Thus due to high sidelobes obtained the noise would be enhanced, which should have to be kept low. From the Figure it can be clearly seen that RLS has high beam width than both LMS and SMI. Summary of the simulation results are shown in the table below

Table 5. 1. Comparison of value of null in undesired direction and side lobe level

	Null in undesired direction(45°)	Side lobe level	First null
LMS	-56.44 dB	-12.64 dB	-33.4 dB at (12°) and -39.73 dB at (-12.08°)
SMI	-48.79 dB	-9.45 dB	-20.27 dB at (10.84°) and -23.26 dB at (-10.93°)
RLS	-49.98 dB	-11.47 dB	-21.24 dB at (13.71°) and -16.64 dB at (-13.22°)

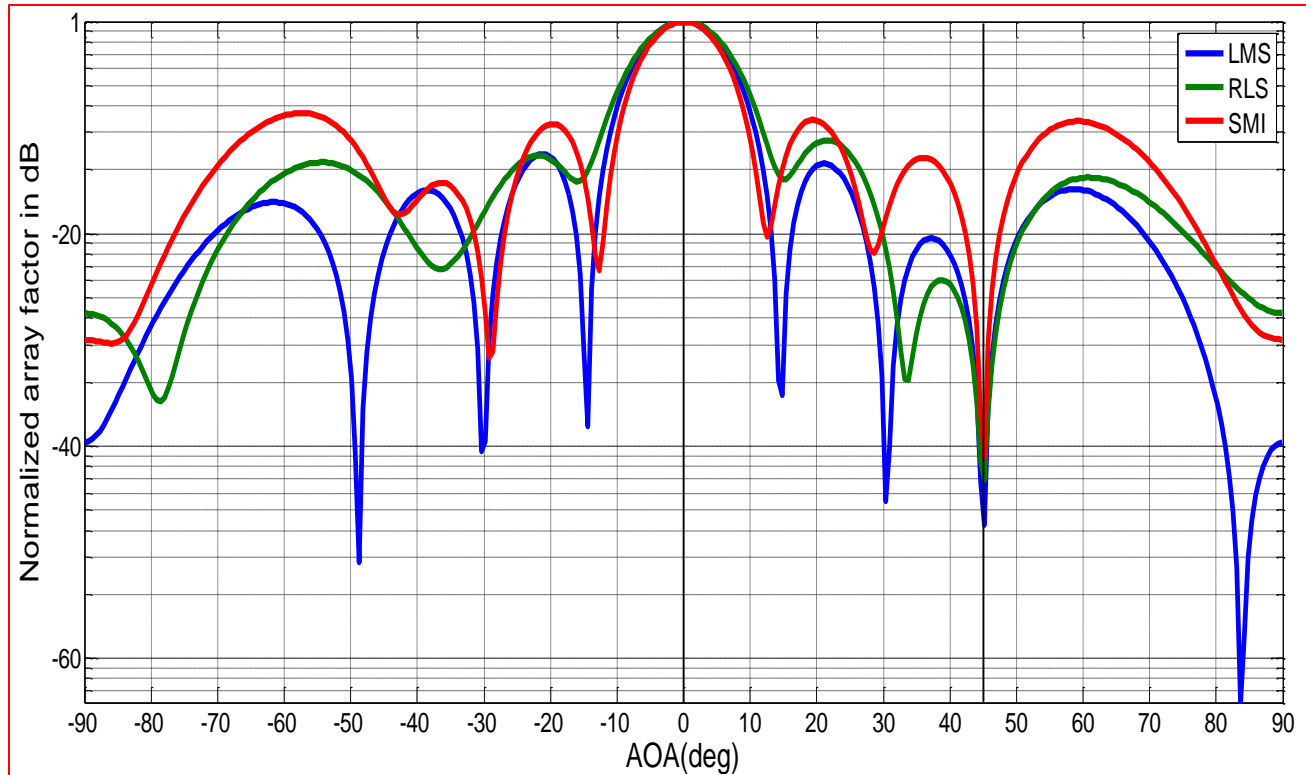

Figure 5.4 Simulation results of radiation pattern, using LMS, SMI and RLS ($d=0.5\lambda$, $N=8$ and arrival angle of 0° for user and 45° for interferer)

5.2 Simulation Result for Different Antenna Spacing

In this section Figure 5.5, 5.6 and 5.7 is plotted to study effect of changing antenna element spacing on performance smart antenna system such as side lobe level as well as on nulling the interferer.

5.2.1 Effect of antenna array spacing using LMS algorithm

From simulation result at the undesired location (45°) using LMS the nulling is better with spacing of 0.6λ compared to others, which is around -53.98dB . Also from Figure 5.5 the maximum side lobe level is comparable bigger (-12.54dB located at -21°) when inter antenna array spacing of 0.5λ and smaller (-13.15dB located at -11.5°) when antenna spacing of 0.9λ is considered. The other point which can be observed from Figure 5.5 is that when the spacing of antenna array increases the separation angle between the first null decreases.

From Figure below, one can easily observe that for spacing of greater or equal to λ grating lobe occurs. Also from Figure 5.5 b $d=0.6 \lambda$ has optimum side lobe level compared to where other spacing is used.

Most of results obtained from figure 5.5 (a) are summarized in figure 5.5 (b) below.

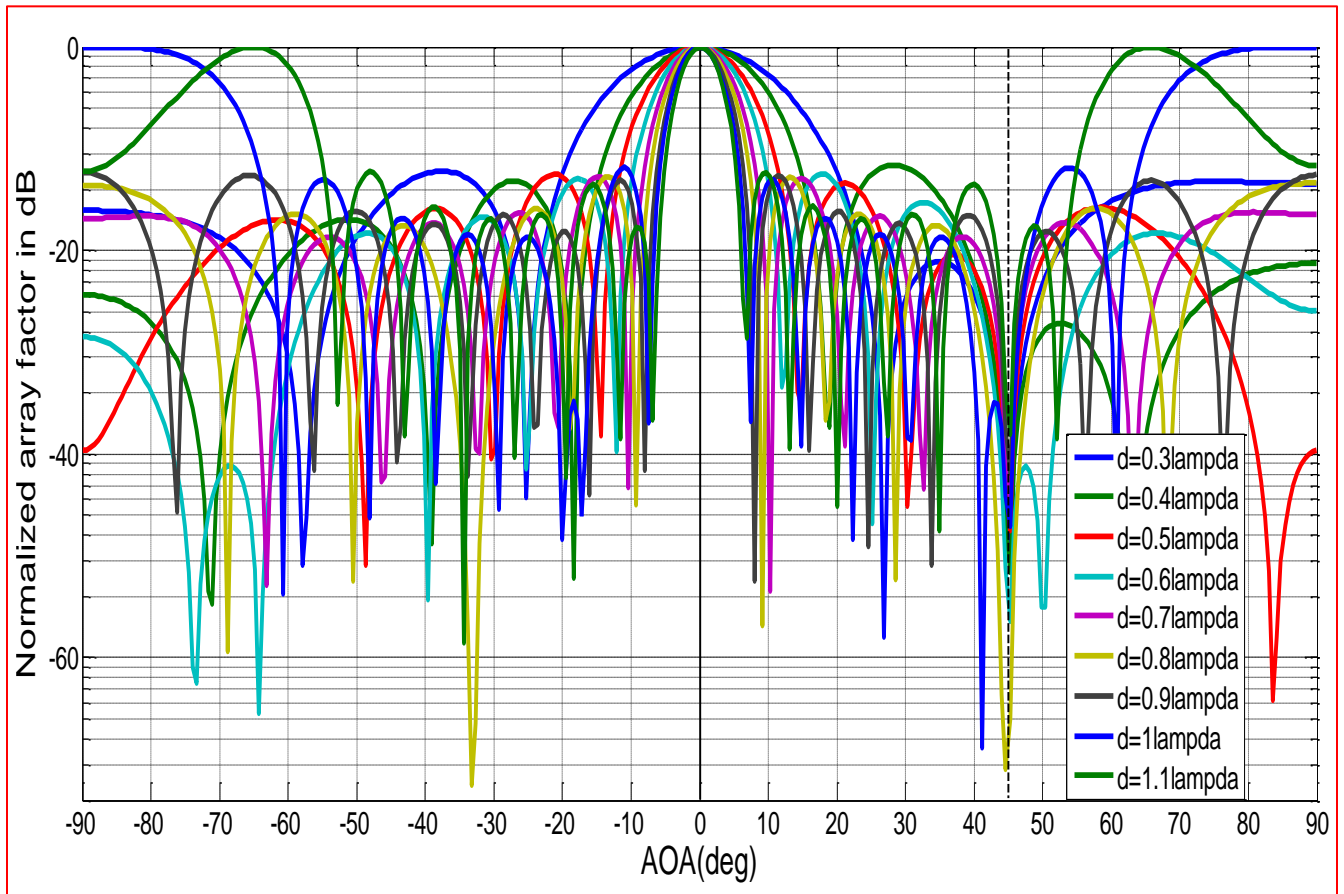

a) Plot of normalized array pattern using LMS for different antenna spacing in dB

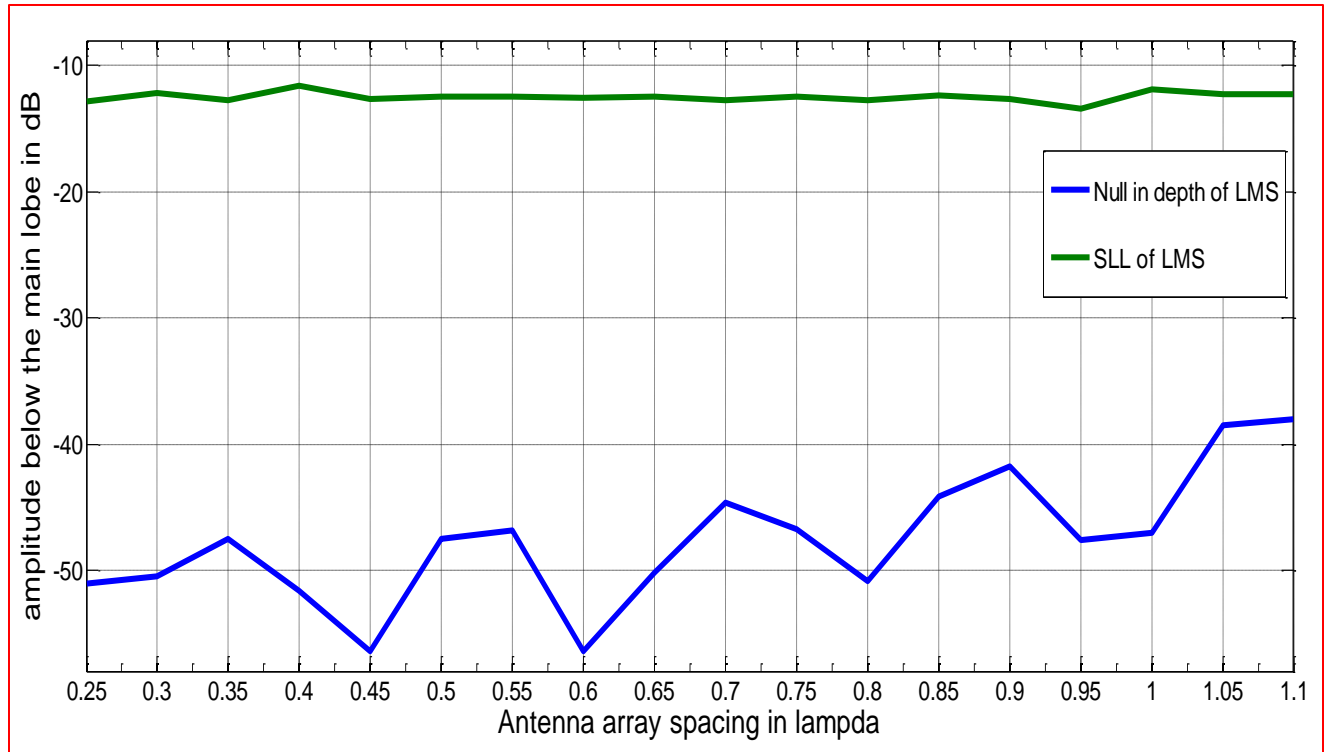

b) Comparison of value of null in undesired direction and side lobe level for different antenna array spacing using LMS

Figure 5.5 Simulation results using LMS for different antenna spacing ($d=0.3 \lambda, 0.4 \lambda, 0.5 \lambda, 0.6 \lambda, 0.7 \lambda, 0.8 \lambda, 0.9 \lambda, 1 \lambda$ and 1.1λ)

Effect of antenna array spacing using SMI algorithm

Figure 5.6 is plotted in the same way to Figure 5.5 above to compare values of null in undesired direction, side lobe level and first null. Accordingly, the value of null in undesired direction (45°) is better when spacing of 0.6λ (-48.79 dB) is used than when any other antenna spacing is used. But when compared to the result from previous section for LMS it is still higher. The other thing is that side lobe level is lower (-9.45 dB at -17°) when inter antenna array spacing is 0.6λ .

From Figure below, one can easily observe that for spacing of greater or equal to λ grating lobe occurs. Also from Figure 5.6(b) spacing of 0.4λ and 0.6λ has optimum side lobe level compared to where other spacing is used.

The rest of simulation results obtained from Figure 5.6 are summarized in Figure 5.6 (b) below.

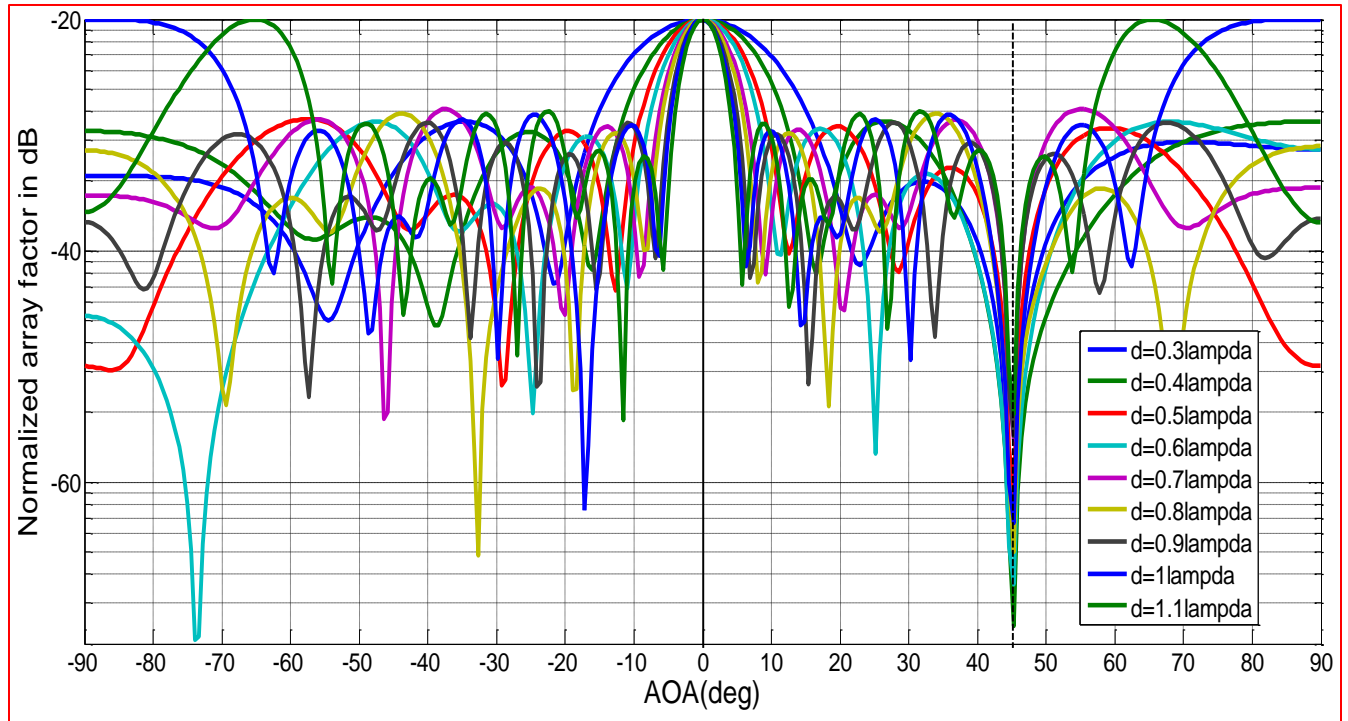

a) Plot of normalized array pattern using SMI for different antenna spacing in dB

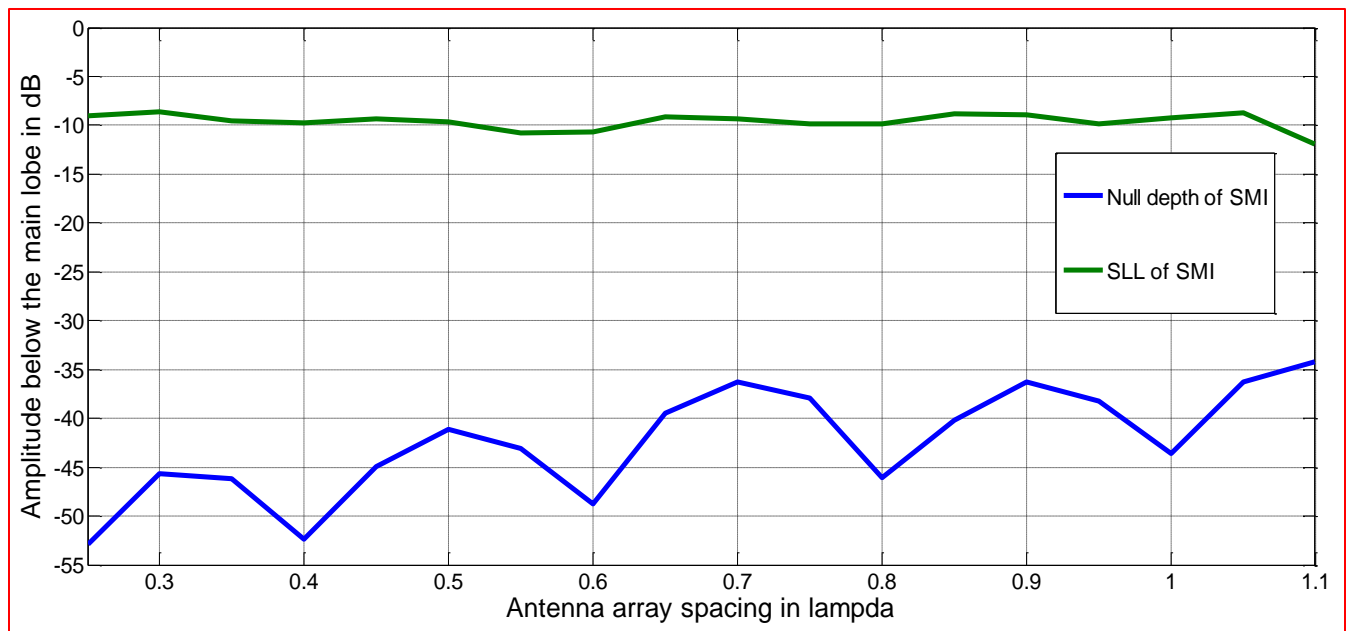

a) Comparison of value of null in undesired direction and side lobe level for different antenna array spacing using SMI

Figure 5.6 Simulation results using SMI for different antenna spacing ($d=0.3\lambda, 0.4\lambda, 0.5\lambda, 0.6\lambda, 0.7\lambda, 0.8\lambda, 0.9\lambda, 1\lambda$ and 1.1λ)

5.2.2 Effect of antenna array spacing using RLS algorithm

In the same way effect of antenna array spacing can be seen from matlab simulation result. Figure 5.7 shows RLS with spacing of 0.6λ has very deep null of (-49.98 dB) in the direction of undesired (45°) signal compared to when different spacing is used. And when the spacing between array antenna is 0.9λ the side lobe level gets higher (-11.06 dB) compared to when spacing is 0.7λ (-12.04dB), which is the lower side-lobe. The rest of simulation results obtained from Figure 5.7 are summarized in figure 5.7 (b) below.

From figure 5.7, it can be observed that increasing inter element spacing produces narrower beams, but with the cost of increasing number of side lobes. Figure 5.8 is plotted to compare the nullifying ability of each beamforming algorithms. Accordingly its can be concluded that the entire algorithm used in this thesis with the assumption taken are capable of nulling interferer source. As it can be seen from figure 5.8 minimum deep null is around -33dB, which is for SMI algorithm with spacing of 1.1λ . But comparably LMS algorithm has still better nullifying ability than SMI and RLS algorithm. It also clear that spacing between elements equal to 0.6λ gives the optimum results and grating occurs when spacing of greater or equal to λ is used.

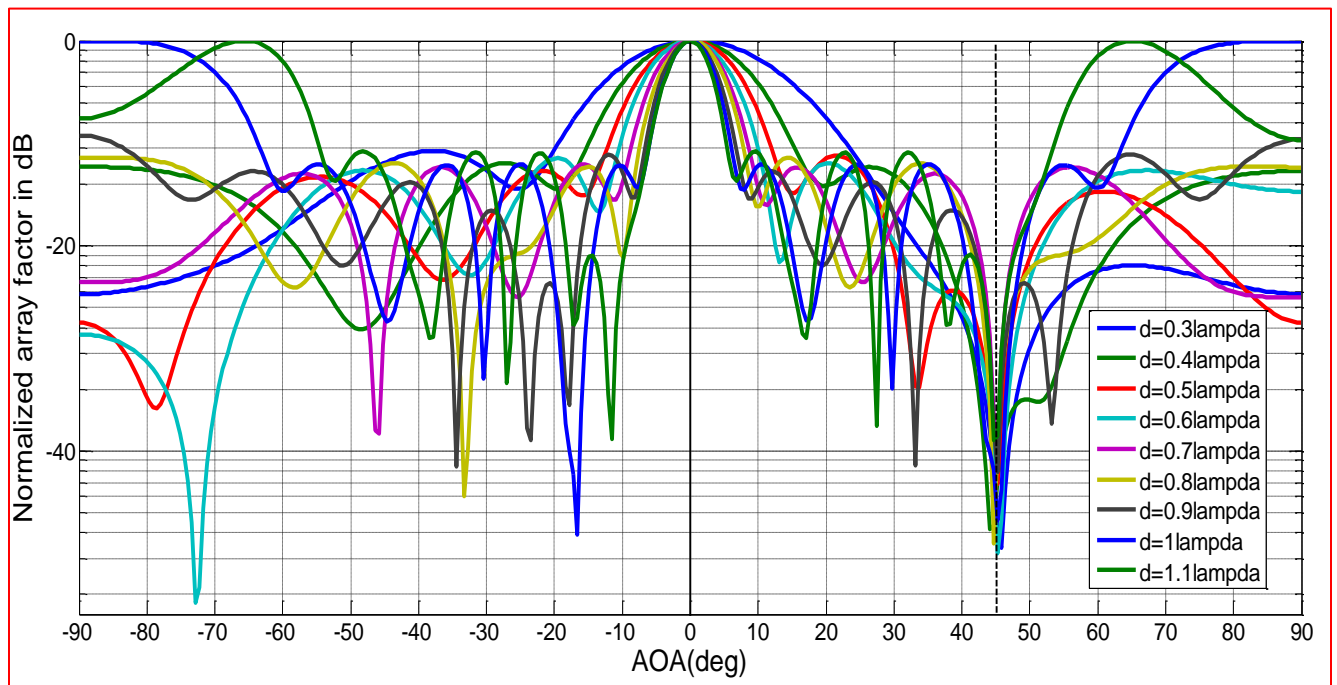

a) Plot of normalized array pattern using RLS for different antenna spacing in dB

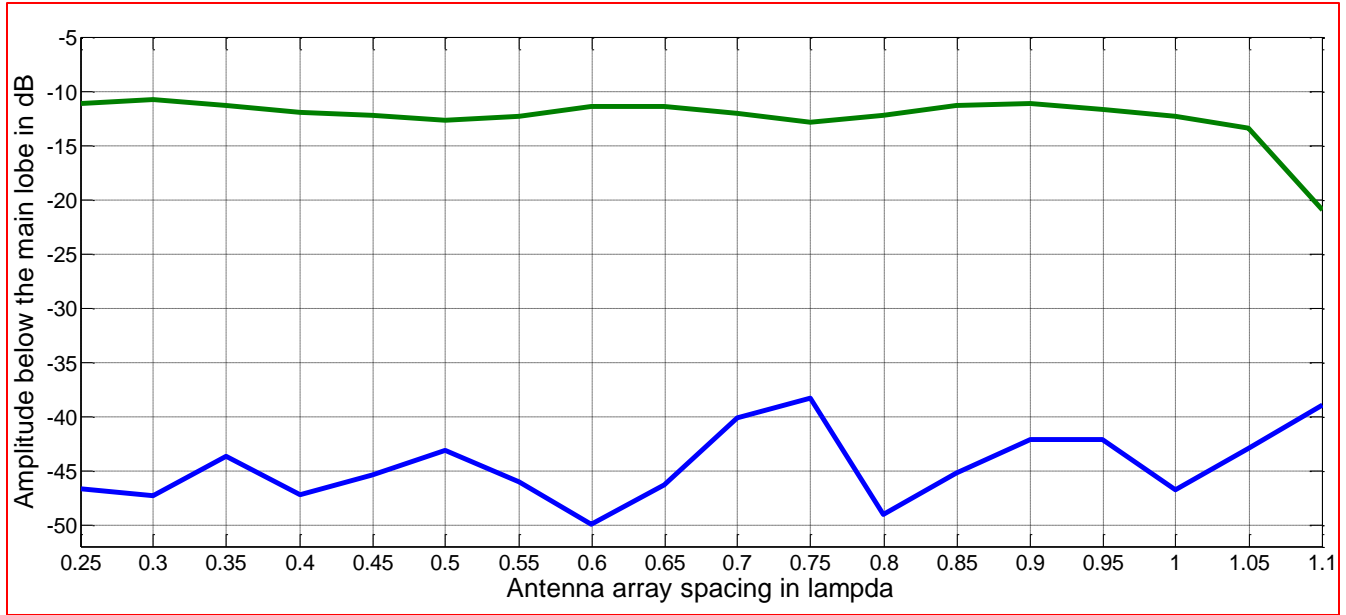

b) Comparison of value of null in undesired direction and side lobe level for different antenna array spacing using RLS

Figure 5.7 Simulation results using RLS for different antenna spacing ($d=0.3 \lambda, 0.4, 0.5\lambda, 0.6\lambda, 0.7\lambda, 0.8 \lambda, 0.9 \lambda, 1 \lambda$ and 1.1λ)

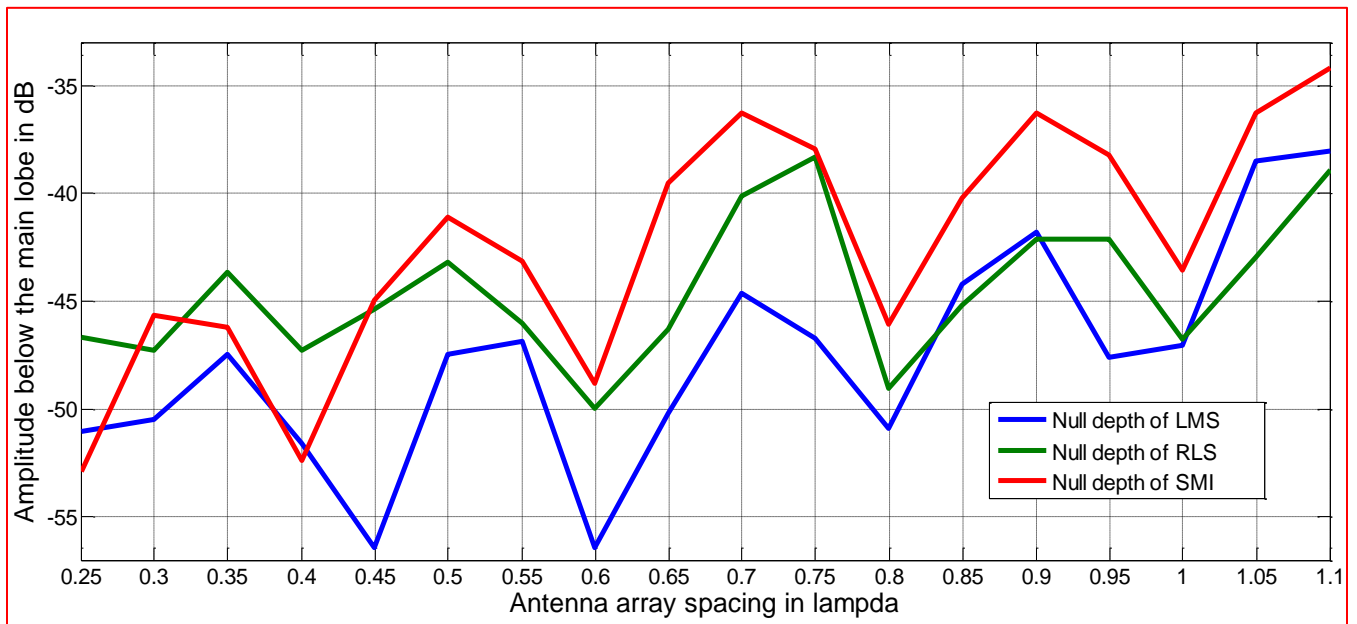

Figure 5.8 Comparison of null depth for different antenna array spacing ($d=0.3 \lambda, 0.4, 0.5\lambda, 0.6\lambda, 0.7\lambda, 0.8 \lambda, 0.9 \lambda, 1 \lambda$ and 1.1λ)

5.3 Simulation result for different number of antenna array

In this section, side-lobe level, null and boresight analysis and comparison is provided based on increasing number of antenna array elements.

5.3.1 Effect of changing antenna array number using LMS algorithm

Figures 5.9, 5.10 and 5.11 are plotted by using LMS, SMI and RLS algorithms (with antenna spacing of $(d=0.6\lambda)$ and dedicated user located at 0° and interferer from 45° direction) respectively, to observe the effects of increasing number of antenna array on side lobe level as well as on nullifying ability of smart antenna system. To study the effect of increasing number of antenna array element on performance of each beamforming algorithms, 6 to 22 number of antenna array element is considered in this section.

From the Figure itself one can easily observe that the beam width gets narrower as the number of antenna array increases. And also from simulation result it's easy to observe all have maximum gain in the direction of dedicated user and almost all have very low gain of (less than -43dB, -37dB and -28dB for LMS, SMI and RLS respectively) in the direction of interferer. Therefore, when only nullifying ability is considered LMS algorithm have better performance than the rest for the same number of antenna array with RLS been worst comparably. Again for maintaining lower side lobes LMS has better result compared to SMI and RLS for same number of array.

As the number of antenna element increases the beam width becomes sharper but with cost of increasing number of side lobes. Figures 5.9, 5.10 and 5.11 below shows that even though the number of side lobes increases with increasing number antenna arrays, the side lobe level is low compared to those generated by array with small number of elements.

As it can be easily seen from Figure 5.9 b the performance of LMS algorithm in making deep null towards the interferer location is more than satisfactory as the minimum null depth seen from simulation result is 45dB below the main lobe. The SLL level is not affected by increasing number of antenna array element as they only depends on signal to noise ratio.

Therefore, when the number of antenna array elements increases the capability of the array in steering in a particular direction increases, but the increase in antenna elements produce an increase in the system noise. Thus, increasing the number of antenna elements in the array results in sharper beams and the overall MSE tends to be almost the same for the given values of antenna element.

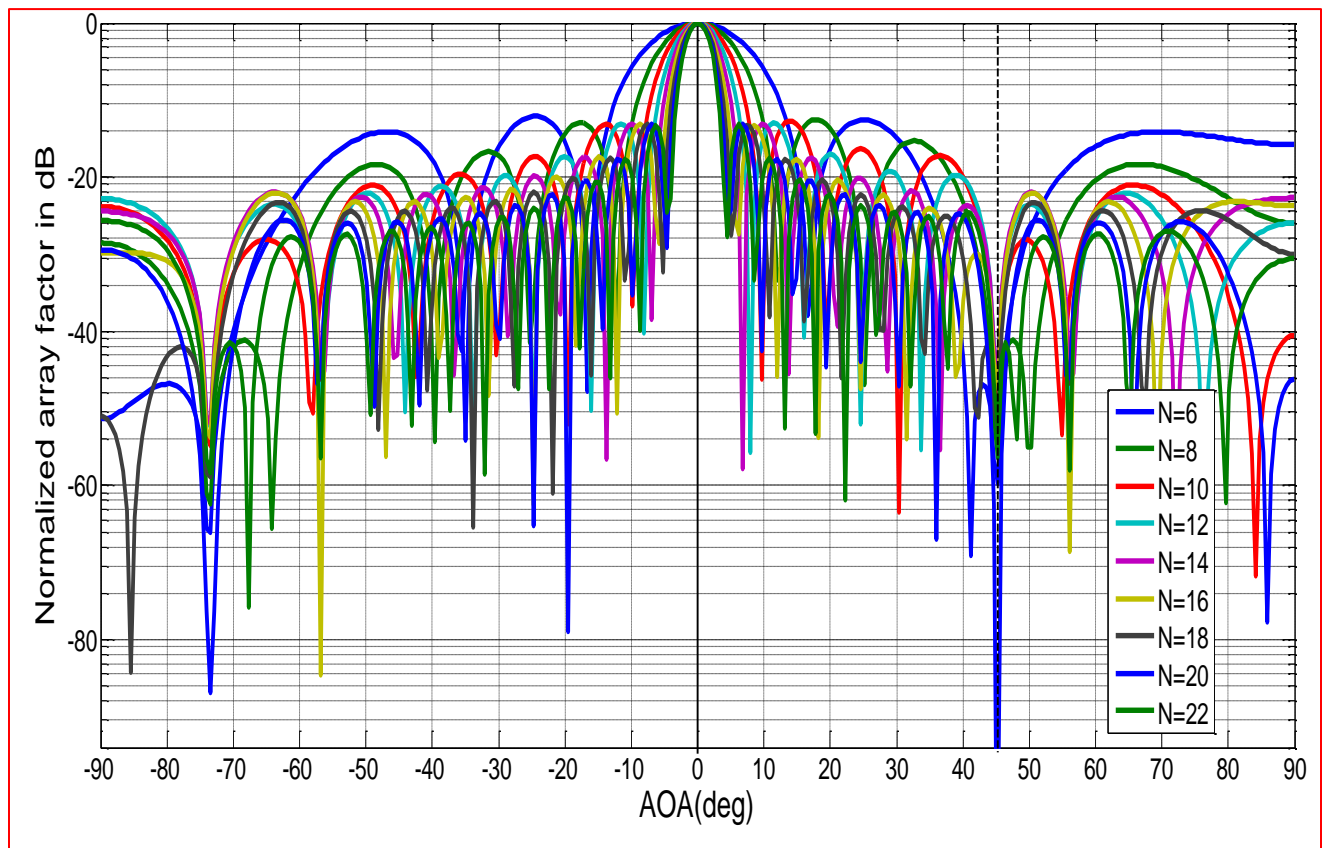

a) Plot of normalized array pattern using LMS for different antenna array number in dB

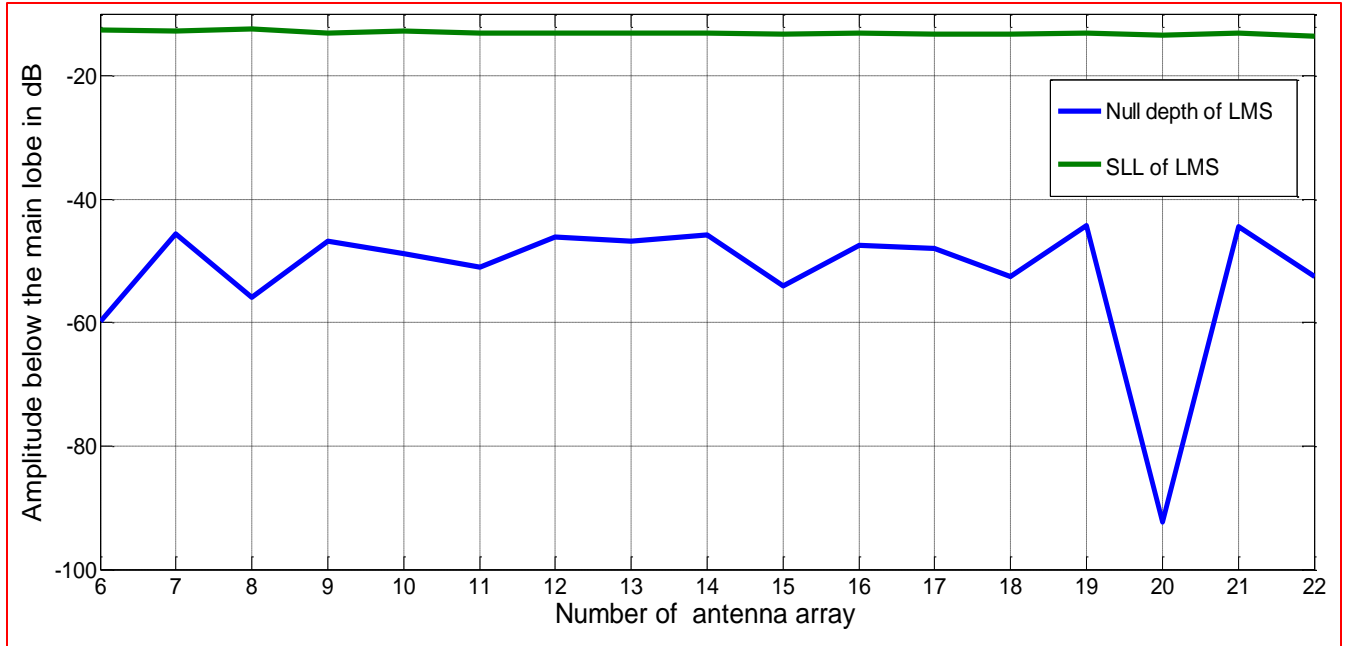

b) Comparison of value of null depth and SLL different antenna array number using LMS

Figure 5.9 Simulation results using LMS for different antenna array numbers ($d=0.6\lambda$).

5.3.2 Effect of changing antenna array number using SMI algorithm

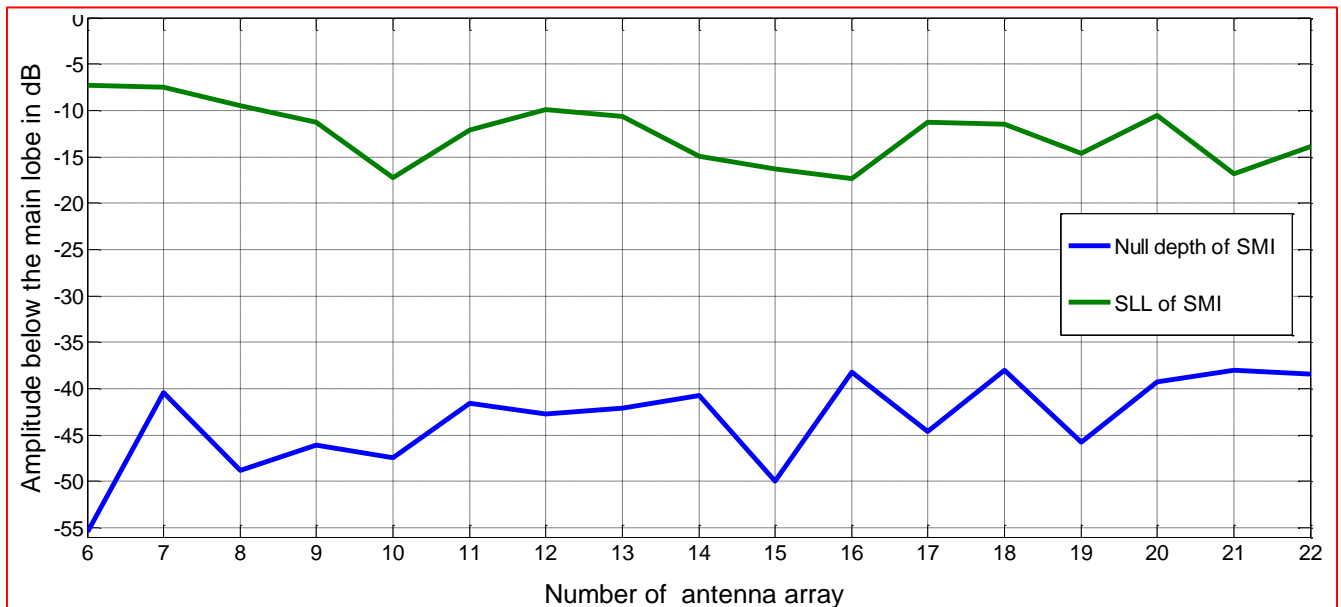

a) Comparison of value of null depth and SLL for different antenna array number using SMI

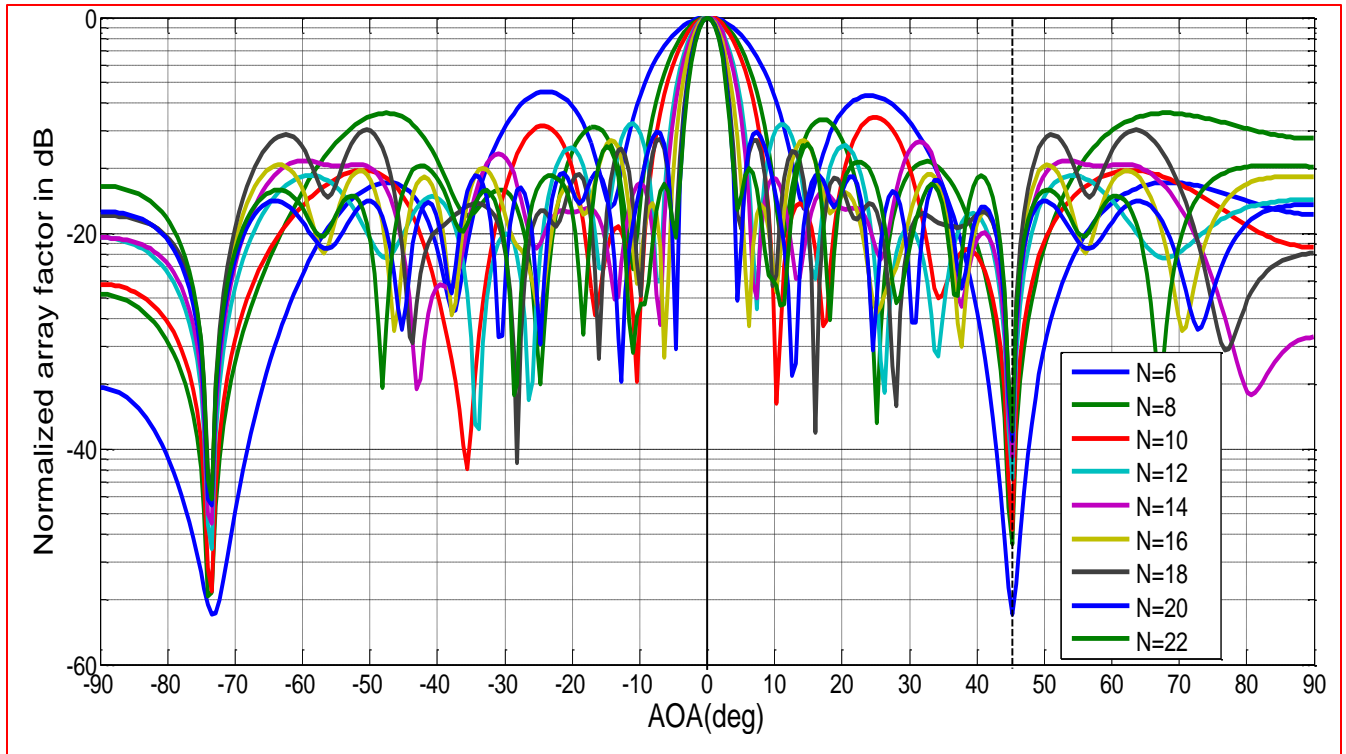

b) Plot of normalized array pattern using SMI for different antenna array number in dB

Figure 5.10 Simulation results using SMI for different antenna array numbers ($d=0.6\lambda$)

5.3.3 Effect of changing antenna array number using RLS algorithm

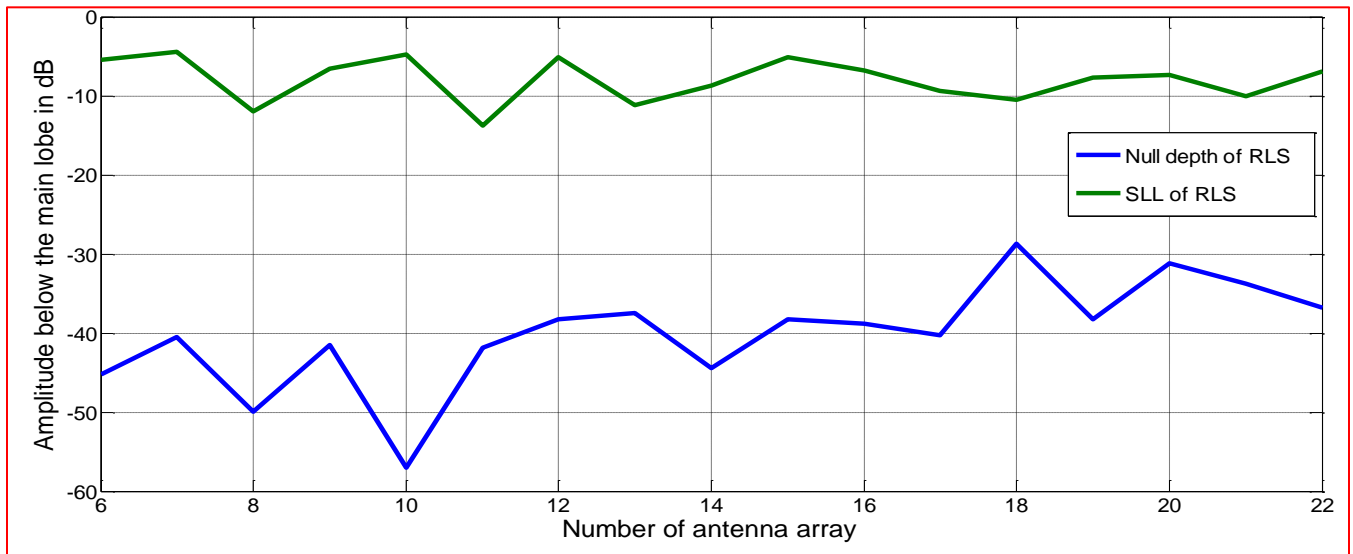

a) Comparison of value of null depth and SLL for different antenna array number using RLS

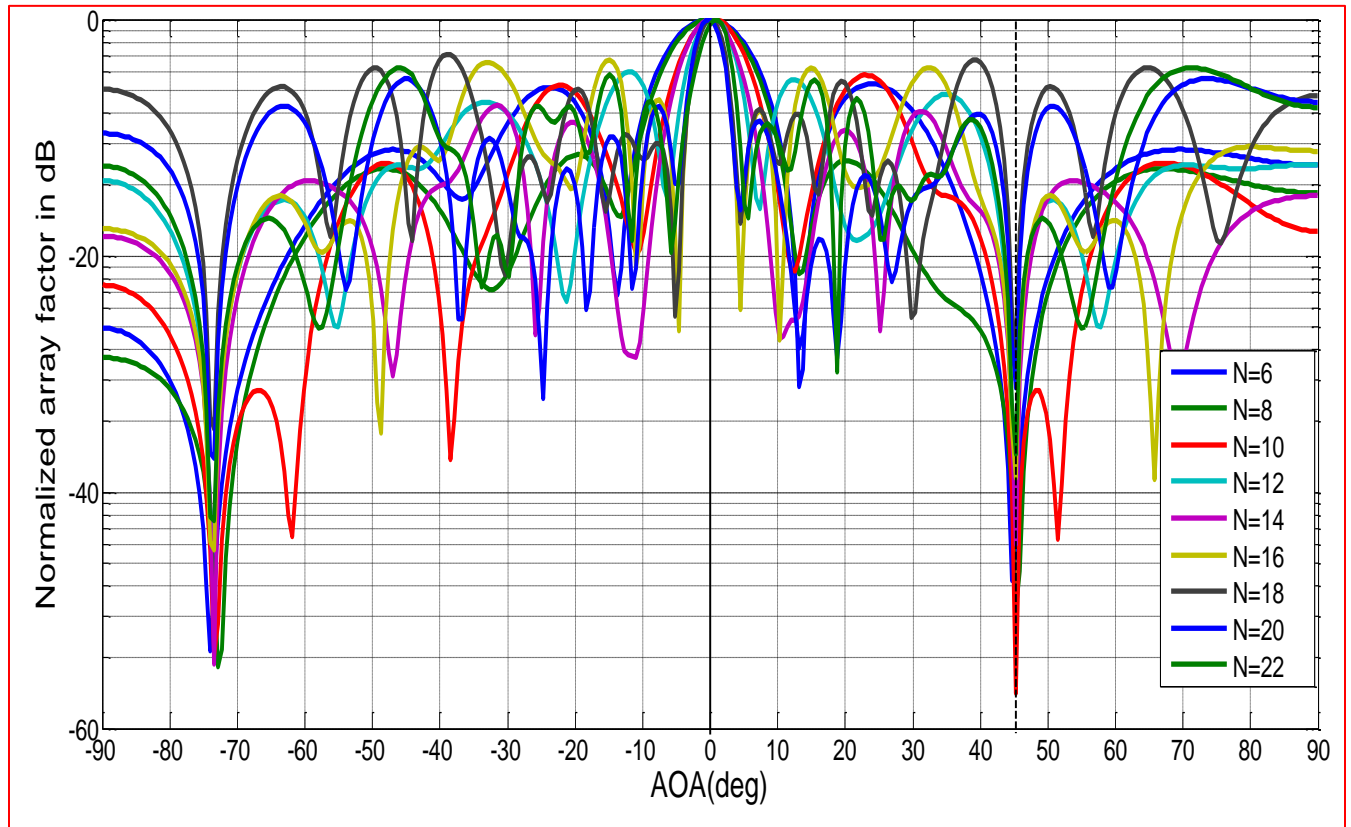

b) Plot of normalized array pattern using RLS for different antenna array number in dB

Figure 5.11 Simulation results using RLS for different antenna array numbers ($d=0.6\lambda$)

5.4 Simulation results for case of more than one interferer

Figure 5.12, 5.13 and 5.14 is plotted on matlab to illustrate the effect of number of interferers. In previous sections the effect of one interferer has been studied and the conclusions were derived. In this section five user is used of which one intended (desired) user (20°) and four interferers (-60° , -30° , 50° , 70°). Linear array of 8 elements and the distance separation between elements is 0.6λ and the minimum separation of angle of arrival used is 20° . Moreover, on the simulation output, the solid line positions infer to the position of intended user and the locations of the dashed lines correspond to the locations of the interferers.

The mean square plot in figure 5.13 (b) shows that the algorithm converges slowly after 160 iteration for 5 users than compared to when the number of users are two after 50 iteration in figure (a) . Also the desired user and array output for both cases are plotted in figure 5.12 for comparison reason.

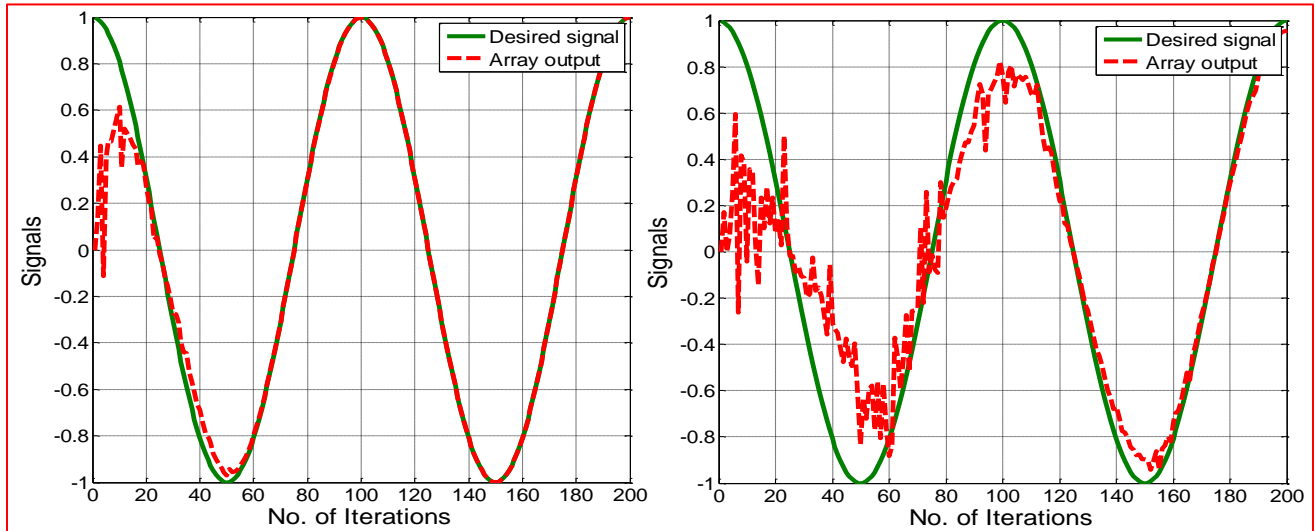

a. One interferer (45°)

b. Four interferers at $(-30, -60, 30, 60)$

Figure 5.12 Array output Vs desired signal ($d=0.6\lambda, \theta_s = 20^\circ, \theta_i = -30^\circ, -60^\circ, 50^\circ$ and 70°)

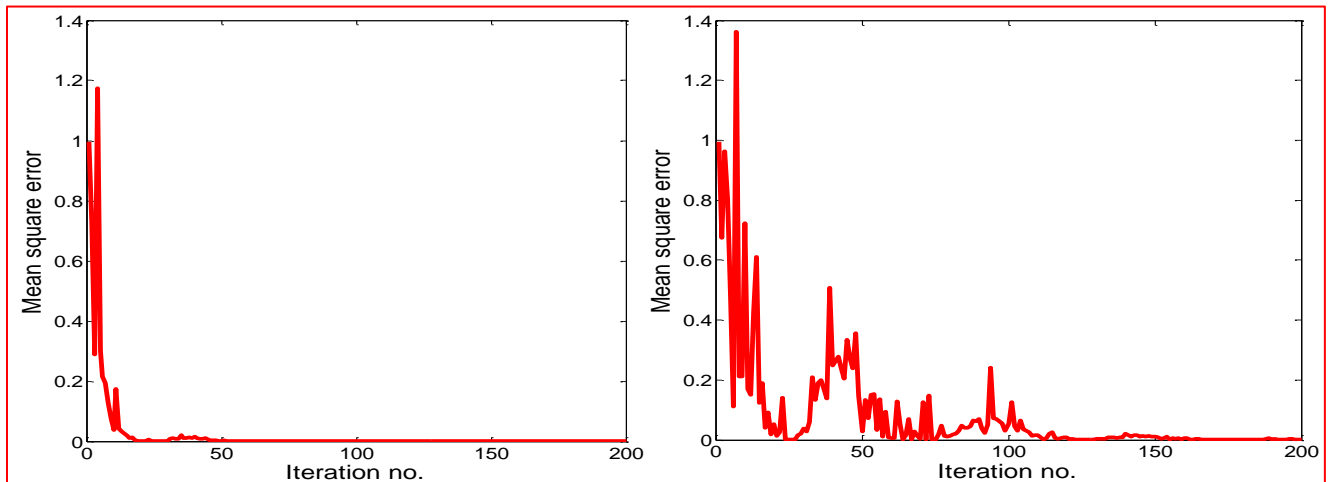

a. One interferer (45°)

b. Four interferers at $(-30^\circ, -60^\circ, 30^\circ, 60^\circ)$

Figure 5.13 Mean square error ($d=0.6\lambda, \theta_s = 0^\circ, \theta_i = -30^\circ, -60^\circ, 30^\circ$ and 60°)

As can be seen from the simulation results LMS has very narrow beam width than RLS and SMI beamforming algorithm, but this comes with cost of increasing number of side lobes. SMI and LMS have very deep null towards the interferer than RLS algorithm. And it can also be easily observed from the result, the SMI beam forming algorithm for increasing number of user has better performance characteristics than RLS algorithm because of their ability in placing deep null towards the interferers and producing much stronger beam towards the intended user as well as low side lobe levels. Generally some numerical results are summarized on table below.

Table 5.3 Comparison of value of null in undesired direction, side lobe level and first null ($d=0.6\lambda$, $N=8$, $\theta_s = 0^\circ$, $\theta_i = -30^\circ, -60^\circ, 30^\circ$ and 60°) for LMS, SMI and RLS algorithms

	LMS	SMI	RLS
Null in undesired direction	-26.02dB (at -60°)	-33.98dB(at -60°)	-18.41dB(at -60°)
	-30.17dB (at -30°)	-23.74 dB(at -30°)	-17.07 dB(at -30°)
	-27.33dB (at 30°)	-31.06 dB(at 30°)	-17.72 dB(at 30°)
	-27.96dB (at 60°)	-21.94 dB(at 60°)	-21.42 dB(at 60°)
First side lobe level	-12.64 dB (at 17.72)	-9.32 dB (at 17.4 ⁰)	-12.20 dB (at 18.84)

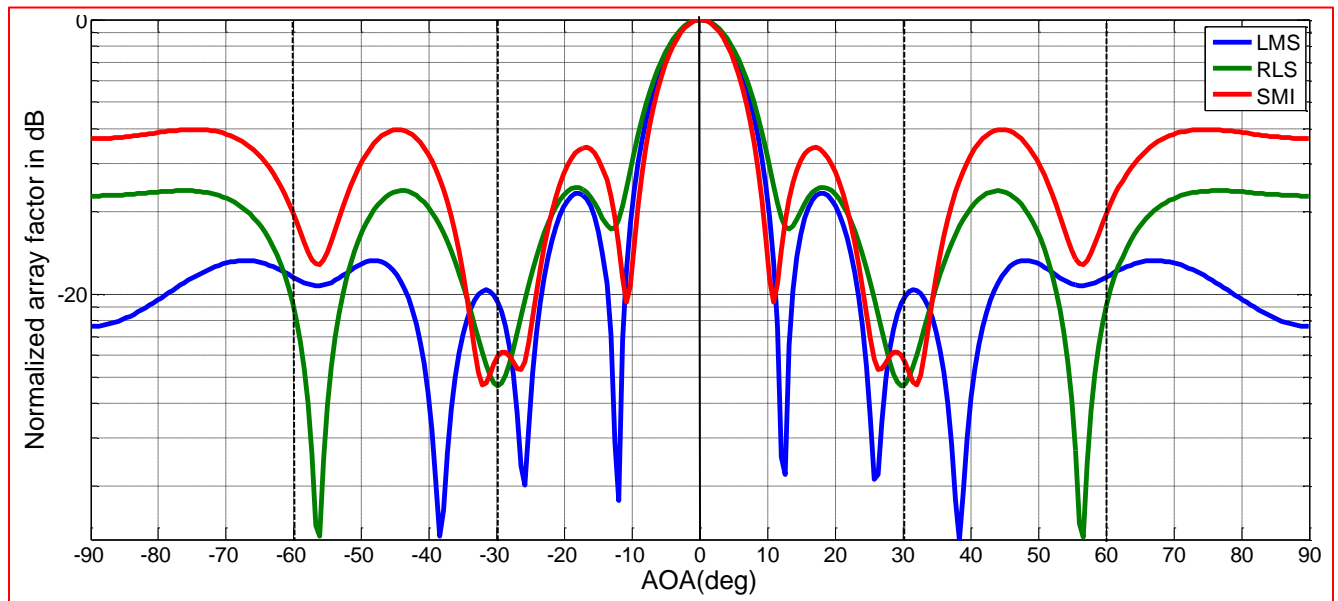

Figure 5.14 Simulation results for comparing SLL and null ($d=0.6\lambda$, $N=8$, $\theta_s = 0^\circ$, $\theta_i = -30^\circ, -60^\circ, 30^\circ$ and 60°) for LMS, SMI and RLS algorithms

5.5 Effect of arrival angle of separation between users

In this section the effect of angle of separation between users is analyzed and studied. In each cases arrival angle of separation of less than 15° (which less than half the first null beam width) is considered and compared with the previous case where the minimum separation between interferers is 20° . Moreover, on the simulation output, the solid line position infer to the position of intended user and the locations of the asterisks dashed lines correspond to the locations of the interferers.

As can be seen from Figure 5.15 nullifying ability of beamforming algorithm degrades with increasing number of users as compared to those of Figure 5.4, as the increase in number of user means the gap between each user is very small. Thus it can be concluded that increasing number of users has big impact on nullifying ability of adaptive beamforming algorithm.

Also from simulation result it can be shown that, SMI algorithm has better performance in placing deep null towards the interferer position than LMS and RLS algorithms when separation between the users is less than half the first null beam width.

Generally some numerical results are summarized on table below.

Table 5.4 Comparison of value of null in undesired direction, side lobe level and first null ($d=0.6\lambda$, $N=8$, $\theta_s = 0^{\circ}$, $\theta_i = -33^{\circ}, -22^{\circ}, -11^{\circ}, 11^{\circ}, 22^{\circ}$ and 33°) for LMS, SMI and RLS algorithms in cases of six interferer where arrival angle of separation 11°

	Side lobe level	Nulling the interferer					
		-33°	-22°	-11°	11°	22°	33°
LMS	-12.68 dB	-16.71 dB	-18.36 dB	-20.51 dB	-19.73dB	-18.08 dB	-17.11dB
RLS	-9.79 dB	-22.82 dB	-13.38 dB	-13.86 dB	-13.74 dB	-13.23 dB	-22.42 dB
SMI	-10.86 dB	-27.56 dB	-16.25 dB	-23.86 dB	-25.01 dB	-16.02 dB	-27.61 dB

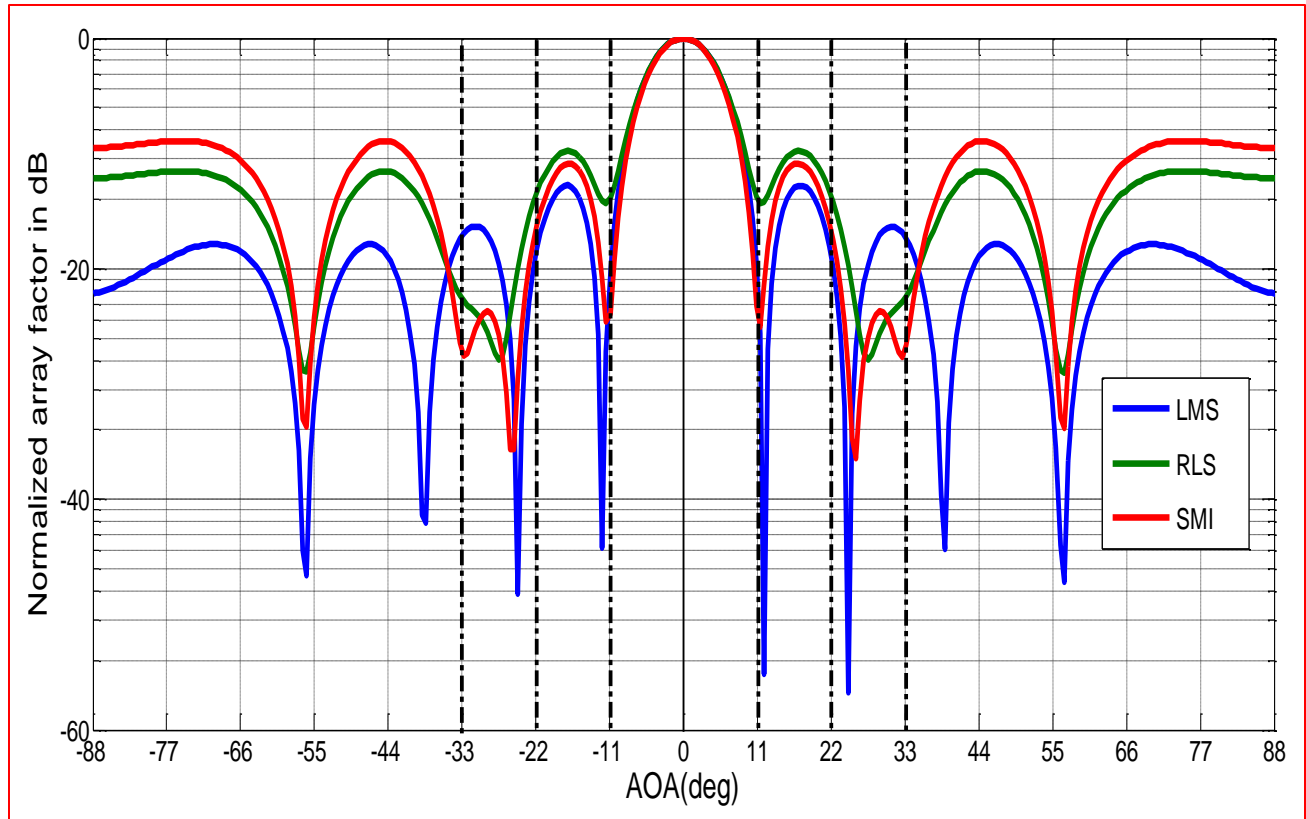

Figure 5.15 Simulation results for comparing sidelobes and null ($d=0.6\lambda$, $N=8$, $\theta_s = 0^\circ$, $\theta_i = -33^\circ, -22^\circ, -11^\circ, 11^\circ, 22^\circ$ and 33°) for LMS, SMI and RLS algorithms in cases of six interferer where arrival angle of separation 11°

Chapter 6

6 Conclusions and Recommendations for Future Work

6.1 Conclusion

Beamforming technique in smart antenna has wide range of solution to cover when it comes to reducing the interference level as well as improving the system capacity and bandwidth. This system makes use of technique to transmit or receive signal only in the direction of intended user from the base station, this in turn will reduce interference and will also increase the capacity.

- The goal of this thesis work is comparing performance of different beamforming techniques in reducing interference level. Up on the analysis of adaptive beamforming algorithms such as LMS, SMI and RLS is done by using matlab simulation. In the simulation of the LMS, SMI and RLS algorithm, the effect of number of antenna array, inter element spacing, number of interferers and separation angle between each user on the performance of adaptive array system such as: side lobe level and Nulling were analyzed in details.
- In all algorithms, increase in number of antenna array element narrows beam towards the intended user but with the cost of increasing number of side lobes. But this will tend lower the side lobe level. LMS algorithm significantly out performs the other beamforming algorithm in placing deep null towards the unwanted user with increase in number of antenna arrays.
- In addition from simulation result, the separation between elements should be less than λ in order to insure that there are no principal maximum in other directions. And also the widths of main lobe decreases with increase in inter element spacing which will result in increase in number of side lobes. Based on simulation results of side lobe level and null, $d=0.6\lambda$ is the optimum value for the antenna array spacing.

- The other observation is that performance degradation due to increase in number of users. However, because of their ability in placing deep null towards the interferers and producing much stronger beam towards the intended user as well as producing low side lobe levels, it can be concluded that, comparably SMI and LMS beamforming algorithm has better performance characteristics than RLS algorithm for higher number of users. In addition, nullifying ability of beamforming algorithm degrades with decrease in separation angle between each user.

6.2 Recommendation

In this thesis work, many important issues have been dealt with but there are issues that have been considered with simplified assumptions. Hence, there are some areas in which the work of this thesis can be extended:

- Narrow band signals and training based (non-blind) algorithms are used in this work. Thus, blind algorithms and wide band signals can be considered for further studies.
- Uniform antenna array spacing is used. Thus, further work can extend this by using non uniform antenna array spacing.
- The minimum separation angle considered in this thesis is 11° . Thus work can extend this by further decreasing gap between user and interferer to 0° .

References

1. M. Usha, K. Nalini, P. Ganesh & T. Raghavendra. "NON-BLIND ADAPTIVE BEAM FORMING ALGORITHMS FOR SMART ANTENNAS". *IJRRAS*, vol. 6, n0. 4, march 2011
2. G. Frank. *Smart antennas for wireless communication with matlab*. Virginia: McGraw-Hill, 2005
3. C.A.Balanis. *Antenna Theory Analysis and Design*. Canada: Wiley-India 3rd edition, 2007
4. S. Jones. *The Basics of Telecommunications*. International engineering consortium, 2005
5. J. D. Kraus & R. J. Markefka. *Antennas for All Application*. NEW DELHI: TATA MCGRAW HILL, 2nd ed, 1997
6. L. Godara. *Smart Antennas*. United States of America: CRC Press LLC, 2004
7. N. Sarma & R. Prakasa. "Adaptive Beamforming Algorithms for Smart Antenna Systems". *WSEAS transaction on communications*, vol.13, 2014
8. S. Rupal, M. Ravi & S. Sumit. "Evaluation of Adaptive Beam Forming Algorithm of Smart Antenna". *International Journal of Scientific Engineering and Technology*. Vol 2, no. 10, 2013
9. S.Chintan & G.Karandika." Algorithms of Adaptive Beam Forming for Smart Antenna: A Comparative Study". *IOSR Journal of Electronics and Communication Engineering*, vol. 8, 2013
10. A. Deshmukh & P. Badadapure. "Survey paper on adaptive beamforming LMS, NLMS AND RLS Algorithms for smart antenna system". *International Journal of Research in Engineering and Technology*, vol. 4, 2015
11. C. Nwalozie., V. Okorogu, S. Maduadichie & A. Adenola. "A Simple Comparative Evaluation of Adaptive Beam forming Algorithms". *International Journal of Engineering and Innovative Technology (IJEIT)*, vol.2, 2013
12. J. Revati & A. Dhande. "Adaptive beam forming using LMS Algorithm". *International Journal of Research in Engineering and Technology(IJRET)*, vol. 3, 2014
13. S. Shaukat, M. Hassan, R. Farooq & Z. Saleem. "Sequential Studies of Beam forming Algorithms for Smart Antenna Systems". *World Applied Sciences Journal*, vol. 6, 2009
14. M. Srikanth, K. Santosh & V. Kumar. "Systematic comparison of performance of different Adaptive beam forming Algorithms for Smart Antenna systems". *IOSR Journal of Electronics and Communication Engineering*, vol. 9, 2014

15. L. Surendra, S.Shameem & Dr. K.Habibullah. "Performance Comparison of LMS, SMI and RLS Adaptive Beamforming Algorithms for Smart Antennas". *IJCST*, vol. 3, 2012
16. P. Yadav & prof. P. Smita. "A COMPARATIVE BEAMFORMING ANALYSIS OF LMS & NLMS ALGORITHMS FOR SMART ANTENNA". *International Journal of Advanced Research in Computer Engineering & Technology (IJARCET)*, vol. 2, 2013
17. M. Karnataka & K. Kumbar. "Adaptive Beamforming Smart Antenna for Wireless Communication System". *International Research Journal of Engineering and Technology (IRJET)*, vol.2, 2015
18. R. Shankar. "A study of adaptive beamforming techniques using smart antenna for mobile communication". M.Thec. thesis, university of Rourkela, 2007
19. S. Kumar & T. Gunasekaran. "Performance Analysis of Adaptive Beamforming Algorithms for Microstrip Smart Antennas". *International Journal of Computing Science and Communication Technologies*, vol. 2, 2009
20. G. Robert & P. Stephen. "Robust Minimum Variance Beamforming". *IEEE TRANSACTIONS ON SIGNAL PROCESSING*, vol. 53, no. 5, 2005
21. S. Girma. "Investigation of Adaptive Beamforming Algorithm for Smart Antenna system to improve the Effect of Angle Separation". M.S.C. thesis, Addis Ababa university, Ethiopia, 2012
22. D. Barry & M. Kevin. "Beamforming : a versatile approach to spatial filtering, IEEE ASSP MAGAZINE", 1988
23. K. Savitri "A Survey on Smart Antenna System". *India international journal of electronics and communication technology*, vol. 2, 2011
24. P. Saxena & G. Kothari. "Performance Analysis of Adaptive Beamforming Algorithms for Smart Antennas". *India International Conference on Future Information Engineering*, 2014
25. M. Ridwan, M. Abdo & J. Eduard. "Performance of a Smart Antenna Equipped Cognitive Radio System in Rayleigh-Fading Channel". *International Journal of Networks and Communications*, vol. 4, 2014
26. M. Atlabachew & M. Abdo. "INVESTIGATION OF ADAPTIVE BEAMFORMING ALGORITHMS FOR COGNITIVE RADIO TECHNOLOGY". *Journal of EEA*, vol. 28, 2011

27. K. Freweyni., A. Tawatu & M. Dilip. “Smart Antenna Techniques for Interference Suppression in WCDMA Using LMS Algorithm”. *International Journal of Computing Science and Communication Technologies*, vol. 6, no. 1, 2013
28. J. Nidhi & Dr. R. Yadav. “Performance Evaluation & Application of Smart Antenna in Sensor Networks”. *IJCTA*, vol. 2, no. 5, 2011
29. J. Manju & G. Vikas. “Performance of Music LMS Algorithm for Smart Antenna”. *International Journal of Scientific Engineering and Technology*, vol. 2, no. 10, 2013
30. V. Vishal & M. Chavan. “PERFORMANCE OF BEAMFORMING FOR SMARTANTENNA USING MODIFIED LMS ALGORITHM”. *International journal of engineering research and science and technology*, vol. 2, no. 3, 2013